

# Multiple Domination in Graphs

Von der Fakultät für Mathematik, Informatik und Naturwissenschaften  
der Rheinisch-Westfälischen Technischen Hochschule Aachen  
zur Erlangung des akademischen Grades  
einer Doktorin der Naturwissenschaften  
genehmigte Dissertation

vorgelegt von

Diplom-Mathematikerin  
Adriana Hansberg Pastor  
aus Mexiko-Stadt

Berichter: Professor Dr. Lutz Volkmann  
Universitätsprofessor Dr. Eberhard Triesch

Tag der mündlichen Prüfung: 17. August 2009

Diese Dissertation ist auf den Internetseiten der Hochschulbibliothek online  
verfügbar.



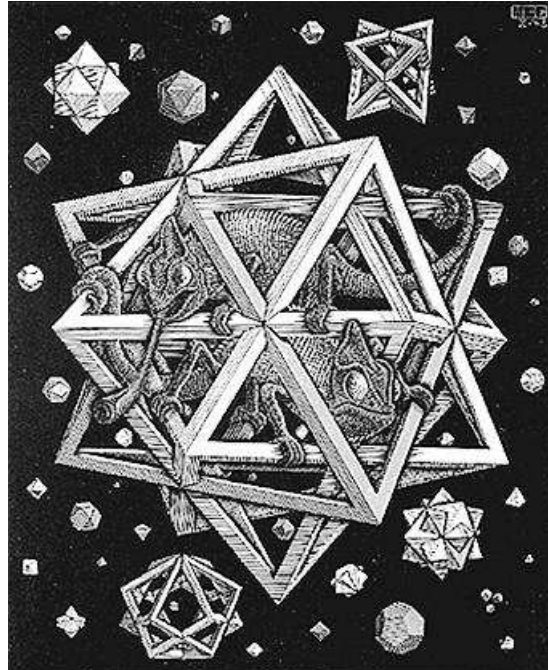

“So let us then try to climb the mountain,  
not by stepping on what is below us,  
but to pull us up at what is above us,  
for my part at the stars.”

M.C. Escher

to my parents  
Teresa and Willi

to my brother and sisters  
Claudio, Valeria and Olivia

to my grandmother  
Olga



# Acknowledgments

Even though, remembering Socrates, I am completely convinced that I still do not know anything, I can affirm that in the past three years I have learned more than ever in all aspects, in particular in the professional one. In these years I submerged into the world of research, the world of the mathematicians, the world of the scientific publications and of conferences. Also into the small world of the institute and of belonging to a work team. All these facets have enriched me enormously and it makes me immensely happy to realize that.

Like every learning process, the beginning was hard and full of emotions. One begins with many illusions and that way one meets with deceptions and frustrations which handicap you the way ahead. And this is not surprising, since, as a novice, one cannot see things clearly. It is like being inside a thick cloud which with the time passing, the experience and the study it becomes step by step brighter. Still I cannot say that I am out this cloud but that I do see a little bit more. And this gives me great satisfaction on the one side, and on the other it urges me on learning further and acquiring more and more knowledge. I have learned that learning gives me very much satisfaction.

I explicitly would like to mention that this learning process could not have been as fruitful and successful as it was without the encouragement of my tutor and teacher Lutz Volkmann. He made me unfold myself in the researching world and knew how to guide and motivate me in my work. For all this and for the great support I have received from his side, I would like to thank him enormously. And for the good communication that we established, I have plain trust and I look forward to working further with him on different future projects.

On the other side, I would like to thank my parents, Teresa and Willi, my brother and sisters, Claudio, Valeria and Olivia, and my grandmother, Olga, for the great backup they have offered to me although living so far away from each other. I want you to know that you are, over everything, the supporting pillar of my life. The fact of living with a big ocean in between, instead of it separating me from you, it only has shown me how much I love you and what you represent to me in my life. Thank you very much for all the love and unconditional support you have given to me all this time.

One person, to whom I owe a lot for all this time together is Manol. Above everyone else, he was the one who was always at my side and with whom I share an infinity of beautiful experiences that mark my epoch in Germany and that I will never forget. Thank you very much for all this time in common, for all adventures together and for all your love and support. I

would also like to thank his family for adopting me like they did and for all the affection and backup in all these years.

Moreover, I would like to thank very specially all my friends over the world, without their backup my life could have been unbearable. Thank you very much for listening to me and for putting up with me, thank you for all your advices and your patience. And thank you all for all those great moments that made my life happy. Specially, I would like to thank immensely Kattia for being such a good friend, for sharing so much with me and for listening always to me, Tatjana for bearing my monologues and standing me by, and Mario for being an unconditional friend who has been always there and for sharing so many adventures together.

I also would like to thank very much Camino for facilitating me the one month research stay at the Universitat Politècnica de Catalunya. Together with her and “her mariachis” I have tasted again the emotion of discussing, not only about things of life, but also about mathematical problems. Thanks to her, I could also get closer to the mathematicians in my country, which has a very special value for me.

At last but not least, I would like to thank a lot the people of the institute, those who are still there and those who have gone their way further, for their support and for the good collegiality that there always was between all of us. I feel very proud of belonging to such an institute, where social life is very much appreciated and where its liberal concept is an exemplar exception for the university. Special thanks to Eberhard Triesch for having contributed in my scientific formation by supporting me in national and international conferences.

To all of them, and all those who have supported me in some way in these years of my doctoral work, I want to express my most profound thanks.

Aachen, May 2009

Adriana Hansberg

# Agradecimientos

A pesar de que, acordándome de Sócrates, estoy completamente convencida de que aún no sé nada, puedo afirmar que en estos últimos tres años de mi vida he aprendido más que nunca en todos los aspectos, en particular en el aspecto profesional. En estos años me he sumergido en el mundo de la investigación, en el mundo de los matemáticos, en el de las publicaciones científicas y en el de los congresos. También en el pequeño mundo del instituto y en el de pertenecer a un grupo de trabajo. Todos estos aspectos me han enriquecido enormemente y me da una alegría inmensa darme cuenta de ello.

Como todo proceso de aprendizaje, el principio fue duro y lleno de emociones. Uno empieza con muchas ilusiones y así se encuentra con decepciones y frustraciones que le dificultan a uno el camino hacia adelante. Y no es de sorprenderse, ya que uno como novato no puede ver las cosas claramente. Es como estar metido en una nube espesa que con el tiempo, con la experiencia y con el estudio se va despejando poco a poco. No puedo decir que he salido de la nube, pero sí que veo un poquito más. Y eso por un lado me da una satisfacción enorme y, por el otro, me urge a seguir aprendiendo y conociendo. He aprendido que el aprender me da mucha satisfacción.

Quiero mencionar explícitamente que este proceso de aprendizaje no hubiera podido ser tan fructífero y exitoso sin mi tutor y maestro, Lutz Volkmann. Él me hizo desenvolverme en el mundo de la investigación y supo guiarme y motivarme en mi trabajo. Por todo esto y por todo el apoyo que he recibido de su parte quiero agradecerle enormemente. Y por la buena comunicación que hemos podido desarrollar, tengo plena confianza y me dará mucho gusto que podamos seguir trabajando juntos en distintos proyectos futuros.

Por otro lado, quiero agradecer inmensamente a mis padres, Teresa y Willi, a mis hermanos, Claudio, Valeria y Olivia, y a mi querida abuela, Olga, por el respaldo tan grande que me han brindado a pesar de encontrarse tan lejos de donde estoy. Quiero que sepan que ustedes son, sobre todas las cosas, el pilar de mi existencia. El hecho de vivir con un océano entremedio, en vez de alejarme de ustedes, sólo me ha mostrado cuánto los quiero y cuánto representan en mi vida. Muchas gracias por ese amor y apoyo incondicional que me han dado durante todo este tiempo.

Una persona a la que le debo muchísimo por todo este largo tiempo compartido es Manol. Él ha sido quien siempre estuvo a mi lado y con quien comparto una infinidad de vivencias hermosas que marcan mi época en Alemania y que nunca olvidaré. Muchas gracias por todo este tiempo

juntos, por todas las aventuras que compartimos y por todo el amor y apoyo que me has dado. También quiero agradecer a su familia por adoptarme como lo hicieron y por todo su cariño y respaldo en todos estos años.

Mas aún, quisiera agradecer muy especialmente a todos mis amigos repartidos por el mundo entero, sin cuyo apoyo mi vida hubiera podido ser un infierno. Muchas gracias por escucharme y aguantarme, muchas gracias por todos los consejos y por su paciencia. Y muchas gracias por todos esos momentos que han alegrado mi vida. En especial, quiero agradecer inmensamente a Kattia por ser tan amiga, por compartir tanto conmigo y por escucharme siempre, a Tatjana por soportar mis monólogos y apoyarme indefinidamente, y a Mario por ser un amigo incondicional que siempre ha estado allí y por compartir conmigo tantas aventuras.

Quiero agradecer también mucho a Camino por facilitarme una estancia de investigación por un mes en la Universitat Politècnica de Catalunya. Con ella y “sus mariachis” he vuelto a saborear la emoción de discutir, no sólo sobre cosas de la vida, sino sobre problemas matemáticos. Gracias a ella, me he logrado acercar más a los matemáticos de mi país, lo cual para mí tiene un valor muy especial.

Por último quiero agradecer mucho a la gente del instituto, a los que siguen y a los que ya continuaron su camino, por el apoyo y el compañerismo que siempre supieron dar. Me siento muy orgullosa de haber sido parte de un instituto en donde se aprecia la convivencia, en donde su concepto liberal es una excepción y un gran ejemplo para la universidad. En especial gracias a Eberhard Triesch por haber colaborado a mi formación científica apoyándome en conferencias nacionales e internacionales.

A todos ellos, y a todos los que durante estos años de mi vida en los que he dedicado a hacer mi doctorado me han apoyado de alguna manera, les doy mis más profundo agradecimiento.

Aachen, Mayo 2009

Adriana Hansberg

# Contents

|  |            |
|--|------------|
| <b>Preface</b>   | <b>xi</b>  |
| <b>1 Introduction</b>  | <b>1</b>   |
| 1.1 Main graph theoretical terminology . . . . .                   | 1          |
| 1.2 The minimum dominating set problem and $k$ -domination . . .   | 3          |
| 1.3 Minimum $f$ -dominating sets in block graphs . . . . .         | 5          |
| <b>2 Bounds on the <math>k</math>-domination number</b>            | <b>15</b>  |
| 2.1 An Erdős-type result and its applications . . . . .            | 15         |
| 2.2 On $k$ -domination and minimum degree . . . . .                | 18         |
| 2.3 On $k$ -domination and usual domination . . . . .              | 28         |
| 2.3.1 Properties of the extremal graphs . . . . .                  | 28         |
| 2.3.2 Graphs with $\gamma = \gamma_2$ . . . . .                    | 43         |
| <b>3 The <math>k</math>-domination number and other parameters</b> | <b>53</b>  |
| 3.1 Independence and $k$ -domination in graphs . . . . .           | 53         |
| 3.2 Independence and 2-domination in graphs . . . . .              | 64         |
| 3.3 Independent domination and 2-domination . . . . .              | 72         |
| 3.4 The $k$ -domination number and the matching number . . . . .   | 81         |
| 3.5 Connected, total and $k$ -domination . . . . .                 | 90         |
| <b>4 Other <math>k</math>-domination parameters</b>                | <b>97</b>  |
| 4.1 The connected $k$ -domination number and related parameters .  | 97         |
| 4.2 The Roman $k$ -domination number . . . . .                     | 103        |
| <b>Bibliography</b>  | <b>107</b> |
| <b>List of notations</b>   | <b>113</b> |
| <b>Index</b>   | <b>115</b> |



# Preface

Given a network, say a computer network or a railway network, it is sometimes of great interest to determine a set of nodes or vertices which “controls” the rest, that is, a set such that every other node is connected to a vertex of the controlling set. It is often of special interest, for instance in view of reducing costs, to find a “controlling” node set with the smallest possible number of nodes. In graph theoretical terminology, this means that, if we have a graph  $G$ , we would like to find a subset  $D$  of the vertex set such that every vertex not in  $D$  has a neighbor in  $D$ . We say then that  $D$  *dominates* the vertices of  $G$ .

The study of domination in graphs turns back to the early 1850’s where chess enthusiasts were interested in finding the minimum number of queens that are needed to place on a chessboard such that every field not occupied by a queen is attacked by at least one. More than a century later, in 1962, Ore [55] was the first in publishing about domination in graphs. From then on, the study of domination in graphs has achieved more and more interest among graph theorists. The two monographs of Haynes, Hedetniemi and Slater [43, 44] testify the relevancy and increased interest of the last years in this topic.

If a “controlling” node or an edge in a network fails, then it is possible that the controlling effect on the vertex set is not anymore guaranteed. Assuming that as a not wished situation, this problem could be prevented increasing the controlling level by demanding every vertex outside the dominating set to have at least  $k \geq 2$  vertices controlling it. With this aim, in 1985, Fink and Jacobson [27, 28] generalized the concept of domination and introduced the so called  $k$ -dominating sets. Here again, we are interested in finding  $k$ -dominating sets of minimum cardinality and denote with  $\gamma_k(G)$  the order of a minimum  $k$ -dominating set in a graph  $G$ . Inspired by Fink and Jacobson, Cockayne, Gamble and Shepherd [20] proved in the same year that the  $k$ -domination number of a graph with minimum degree  $\delta \geq k$  is at most  $k/(k+1)$  times its order. Further results followed in 1985 and 1988 by Favaron [23, 24], by Jacobson and Peters [48] in 1989, and later, in 1990, by Caro

[11], Caro and Roditty [12] and Jacobson, Peters and Rall [49]. Since then, the concept of  $k$ -domination has gained increased popularity among graph theorists. More recent results can be found in [7, 8, 13, 14, 18, 61, 66, 69, 70]. However, there is still very much to do in this field and, with this purpose, this thesis aims basically to make a contribution to the study of  $k$ -domination in graphs.

In the first chapter, we introduce the concepts of domination and  $k$ -domination. As it was shown in 1989 by Jacobson and Peters [48], the problem of finding a minimum  $k$ -dominating set belongs to the class of NP-hard problems. However, for some graph classes this problem turns polynomial. We present here a polynomial algorithm for finding a minimum  $f$ -dominating set in a block graph, where  $f$ -domination is an even more general concept as  $k$ -domination. This algorithm comprises those of Volkmann [67] for finding a minimum dominating set in a block graph, of Hedetniemi, Laskar and Pfaff (see [45]) for finding minimum  $f$ -dominating sets in trees and of Jacobson and Peters [48] for determining a minimum  $k$ -dominating set in a tree.

The second chapter handles with different bounds on the  $k$ -domination number. First, we present an Erdős-type argument that is useful in proving different inequalities, in particular, beside some new bounds on the  $k$ -domination number, we derive a classical bound on the  $k$ -domination number due to Caro and Roditty [12] and another of Hopkins and Staton [47] on the  $k$ -dependence number. Moreover, we are able to characterize the graphs achieving equality in the bound of Cockayne, Gamble and Shepherd [20] mentioned above. Further, we use a probabilistic method in order to obtain other upper bounds for the  $k$ -domination number. As a consequence of one of these probabilistic approaches, it follows the well-known inequality  $\gamma(G) \leq n(\ln(\delta+1)+1)/(\delta+1)$  for the usual domination number  $\gamma(G)$  by Arnaoutov [3], Lovász [52] and Payan [57], where  $n$  is the order and  $\delta \geq 1$  the minimum degree of the graph  $G$ . The last part of this chapter is devoted to the analysis of the graphs achieving equality in the bound  $\gamma_k(G) \geq \gamma(G) + k - 2$  for graphs with maximum degree at least  $k \geq 2$ , given by Fink and Jacobson in one of their introducing papers [27]. As easy as it is to prove this bound, as difficult it seems the characterization of the equality for arbitrary graphs. Even the case  $k = 2$  looks extremely complicated. However, we tackle the problem, and towards a solution, we present different interesting properties of the extremal graphs. In particular, we show that such graphs contain many induced cycles of length four. Moreover, we characterize the claw-free graphs, the line graphs and the cactus graphs with equal 2-domination and domination numbers.

In Chapter 3, we compare the  $k$ -domination number with other graph parameters. Among other results concerning the parameter  $\alpha(G)$  for the

---

independence number, we show, applying also the well-known theorem of Brooks for the chromatic number, that every connected graph  $G$  with minimum degree  $\delta \geq k$  fulfills  $\gamma_k(G) \leq (\Delta - 1)\alpha(G)$ , if  $G$  is neither the complete graph on  $k + 1$  vertices nor, in case that  $k = 2$ , a cycle of odd length. We also give a characterization for the non-regular graphs attaining equality and the regular case remains as a conjecture. Moreover, we prove that, for bipartite graphs  $G$ ,  $\gamma_2(G) \leq 3\alpha(G)/2$  holds and we obtain a nice characterization of the extremal graphs. Further, we analyze the connections between the 2-domination number and the independent domination number  $i(G)$ , which denotes the minimum cardinality of an independent dominating set in  $G$ , and we obtain similar results to previous given ones concerning usual domination. Finally, we explore the relations between the  $k$ -domination number and the matching number, the connected domination number and the total domination number.

The fourth and last chapter is devoted to special  $k$ -domination parameters, where, apart from being  $k$ -dominating, we demand the  $k$ -dominating set to fulfill further properties, like for example that the underlying induced subgraph is connected or that not only the vertices outside the dominating set but also the vertices inside should be  $k$ -dominated. Regarding the respective parameters for the minimum number of vertices required for a subset of vertices in a graph to be  $k$ -dominating and satisfying a determined property, we develop some interesting bounds that often either generalize or improve known ones.



# Chapter 1

## Introduction

### 1.1 Main graph theoretical terminology

We consider finite, undirected and simple graphs  $G = (V(G), E(G))$  with vertex set  $V = V(G)$  and edge set  $E = E(G)$ . If multiple edges are allowed, we will specify the graph as a *multigraph*, otherwise we will call it only *graph*. The number of vertices  $|V(G)|$  of a graph  $G$  is called the *order* of  $G$  and is denoted by  $n = n(G)$  and  $m = m(G)$  is the number of edges or rather the *size* of  $G$ . If  $A$  and  $B$  are two disjoint subsets of the vertex set, then  $(A, B)$  is the set of edges with one end vertex in  $A$  and one in  $B$  and  $m(A, B)$  denotes its cardinality.

The *open neighborhood*  $N(v) = N_G(v)$  of a vertex  $v$  consists of the vertices adjacent to  $v$  and  $d(v) = d_G(v) = |N(v)|$  is the *degree* of  $v$ . The *closed neighborhood* of a vertex  $v \in V$  is the set  $N[v] = N_G[v] = N(v) \cup \{v\}$ . For a subset  $S \subseteq V(G)$ , we define  $N(S) = N_G(S) = \bigcup_{v \in S} N(v)$ ,  $N[S] = N_G[S] = N(S) \cup S$ , and  $G[S]$  is the subgraph *induced by*  $S$ , that is the graph with vertex set  $S$  and edge set  $\{uv : u, v \in S, uv \in E(G)\}$ . If  $H$  is a subgraph of  $G$  and  $S$  is a subset of  $V(G)$ , we denote with  $N_G(S, H)$  the set of neighbors of  $S$  with respect to  $H$ , that is, the set  $N_G(S) \cap V(H)$ . We denote with  $\delta(G)$  and  $\Delta(G)$  the minimum and, respectively, the maximum of all degrees of the vertices of  $G$ . A vertex of degree one is called a *leaf*. We denote the set of leaves of  $G$  with  $L(G)$ . The *distance*  $d(x, y) = d_G(x, y)$  of two vertices  $x$  and  $y$  of a connected graph  $G$  is the length of a path of minimum length with end vertices  $x$  and  $y$ . The graph  $\overline{G}$  is called the *complement* of  $G$  and is defined as the graph with vertex set  $V(\overline{G}) = V(G)$  and edge set  $E(\overline{G})$  such that  $e \in E(\overline{G})$  if and only if  $e \notin E(G)$ . A *regular graph* is a graph whose vertices have all the same degree. If  $d(x) = r$  for all  $x \in V(G)$ , we call  $G$  *r-regular* and if  $d(x) \in \{r, r + 1\}$  we say that  $G$  is *semiregular*.

We denote with  $K_n$  the complete graph of order  $n$  and with  $C_n$  the *cycle* of length  $n$ . A connected acyclic graph is called a *tree*. A graph with exactly one induced cycle is called *unicyclic*. A *clique* in a graph is an induced complete subgraph. Let  $G_1$  and  $G_2$  be two graphs. The  $G_2$ -*corona* of  $G_1$  is the graph  $G_1 \circ G_2$  formed from one copy of  $G_1$  and  $n(G_1)$  copies of  $G_2$  where the  $i$ th vertex of  $G_1$  is adjacent to every vertex in the  $i$ th copy of  $G_2$ . If  $G_2 \cong K_1$ , then we call  $G_1 \circ G_2$  the *corona graph* of  $G_1$ . We refer to the *complete bipartite graph* with partition sets of cardinality  $p$  and  $q$  as the graph  $K_{p,q}$ . A *triangulated* graph  $G$  is a graph with no induced cycles of length 4 or larger. A graph  $G$  is called *cubic* if every vertex in  $V(G)$  has degree three.

A *cut vertex* in a graph  $G$  is a vertex whose removal increases the number of components of  $G$ . Analogously, a *bridge* in  $G$  is an edge whose removal increases the number of components. A *block* of  $G$  is an induced subgraph without cut vertices of maximum cardinality. We say to a block to be an *end block* if it contains at most one cut vertex of  $G$ . A graph  $G$  is a *block-cactus graph* if every block of  $G$  is either a complete graph or a cycle.  $G$  is a *cactus graph* if every block of  $G$  is a cycle or a  $K_2$  and it is a *block graph* if every block is a clique. If we substitute each edge in a nontrivial tree by two parallel edges and then subdivide each edge, then we speak of a  $C_4$ -*cactus*.

The *subdivision graph*  $S(G)$  of a graph  $G$  is that graph obtained from  $G$  by replacing each edge  $uv$  of  $G$  by a vertex  $w$  and edges  $uw$  and  $vw$ . In the case that  $G$  is the trivial graph, we define  $S(G) = G$ . Let  $SS_t$  be the subdivision graph of the *star*  $K_{1,t}$ . A tree is a *double star* if it contains exactly two vertices of degree at least two. A double star with respectively  $s$  and  $t$  leaves attached at each support vertex is denoted by  $S_{s,t}$ . Instead of  $S(S_{s,t})$  we write  $SS_{s,t}$ . A *generalized star* is a tree that results from a star  $K_{1,t}$  by subdividing its edges arbitrary many times.

Let  $\mathcal{P}$  be a property defined on sets of vertices. We say that  $S \subseteq V(G)$  is *maximum (minimum)* in  $G$  with respect to the property  $\mathcal{P}$  if  $S$  has the property  $\mathcal{P}$  and, among all subsets of  $V(G)$  with this property, it is of maximum (minimum) cardinality. Let  $\varphi(G)$  denote the cardinality of a maximum (minimum) subset of  $V(G)$  with respect to the property  $\mathcal{P}$ . If  $S$  has the property  $\mathcal{P}$  and  $|S| = \varphi(G)$ , we call  $S$  a  $\varphi(G)$ -*set*.

A mapping  $h : V(G) \rightarrow \{1, 2, \dots, q\}$  is called a *coloring* of the vertex set of  $G$ , where the values  $1, 2, \dots, q$  are called the *colors*. If no two adjacent vertices  $x, y \in V(G)$  have the same color, that is if  $h(x) \neq h(y)$ , we say the coloring  $h$  to be *proper*. A proper coloring of  $G$  with the minimum number of colors is a *minimum coloring* of  $G$  and the *chromatic number*  $\chi(G)$  is the cardinality of a minimum proper vertex coloring of  $G$ .

## 1.2 The minimum dominating set problem and $k$ -domination

In the 1850s, chess enthusiasts in Europe considered the problem of determining the minimum number of queens that can be placed on a chessboard so that all squares are either attacked by a queen or are occupied by a queen. It was correctly thought in that time that five is the minimum number of queens that can dominate all of the squares of an  $8 \times 8$  chessboard (see Figure 1.1).

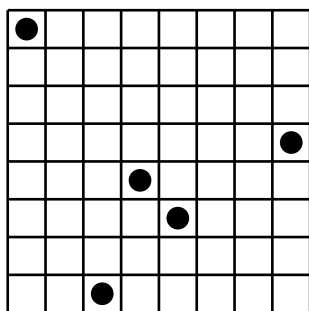

Figure 1.1: Five queens dominating the chessboard.

The problem of dominating the squares of a chessboard can be stated more generally as a problem of dominating the vertices of a graph. A subset  $S$  of  $V$  is called *dominating* in  $G$  if every vertex of  $V - S$  has at least one neighbor in  $S$ . The *domination number*  $\gamma(G)$  is the minimum cardinality of a dominating set of  $G$ . Let  $Q_n$  be the graph that has the squares of the  $n \times n$  chessboard as its vertices and two squares are adjacent if they are in the same row, column, or diagonal. Then the minimum number of queens that dominate the  $n \times n$  chessboard is equal to  $\gamma(Q_n)$ . The problem of finding the domination number of the queen's graph has interested mathematicians for well over a century. Until now,  $\gamma(Q_n)$  is only known for small values of  $n$  and other special cases (see [56] for more information). The problem of finding a minimum dominating set in a general graph has been shown by Garey and Johnson [31] in 1979 to be NP-hard. Therefore, most of the study of domination in graphs is based on finding good bounds for the domination number. Evidently  $1 \leq \gamma(G) \leq n$  for any graph  $G$  on  $n$  vertices. For graphs without isolated vertices, the upper bound was improved considerably by Ore in 1962, who was the first in publishing results about dominating sets in graphs.

**Theorem 1.1** (Ore [55], 1962) *If  $G$  is a graph without isolated vertices, then  $\gamma(G) \leq n(G)/2$ .*

The graphs of even order achieving equality in previous bound were characterized independently by Payan and Xuong in 1982 and Fink, Jacobson, Kinch and Roberts in 1985.

**Theorem 1.2** (Payan, Xuong [58], 1982, Fink, Jacobson, Kinch, Roberts [29], 1985) *Let  $G$  be a connected graph. Then  $\gamma(G) = n(G)/2$  if and only if  $G$  is the  $K_1$ -corona graph of any connected graph  $J$  or  $G$  is isomorphic to the cycle  $C_4$ .*

In 1998, Randerath and Volkmann [60] and independently, in 2000, Xu, Cockayne, Haynes, Hedetniemi and Zhou [21] characterized the odd order graphs  $G$  for which  $\gamma(G) = \lfloor n(G)/2 \rfloor$ .

The search for good upper bounds for the domination number in terms of order and minimum degree has been a very discussed topic in the study of domination. Some important bounds of this kind are given in [46, 53, 54, 62, 64, 73]. For a more comprehensive treatment on domination in graphs, see the monographs by Haynes, Hedetniemi and Slater [43, 44].

A dominating set  $D$  in a graph can be seen as a set of vertices or nodes controlling or monitoring the vertices in  $V - D$ . Then the removal or failure of a vertex in  $D$  or of an arbitrary edge, may cause the set  $D$  to be not dominating anymore. If this is an undesirable situation, then it may be necessary to increase the level of domination of each vertex, so that, even if a vertex or edge fails, the set  $D$  will still be a dominating set in  $G$ . This idea led Fink and Jacobson [27, 28] in 1985 to introduce the concept of *multiple domination*. A subset  $D \subseteq V$  is  *$k$ -dominating* in  $G$  if every vertex of  $V - D$  has at least  $k$  neighbors in  $S$ . The cardinality of a minimum  $k$ -dominating set is called the  *$k$ -domination number*  $\gamma_k(G)$  of  $G$ . Clearly,  $\gamma_1(G) = \gamma(G)$ . Naturally, every  $k$ -dominating set of a graph  $G$  contains all vertices of degree less than  $k$  and, if  $n \geq k$ ,  $\gamma_k(G) \geq k$ . Of course, every  $(k + 1)$ -dominating set is also a  $k$ -dominating set and so  $\gamma_k(G) \leq \gamma_{k+1}(G)$ . Moreover, the vertex set  $V$  is the only  $(\Delta + 1)$ -dominating set but evidently it is not a minimum  $\Delta$ -dominating set. Thus every graph  $G$  satisfies

$$\gamma(G) = \gamma_1(G) \leq \gamma_2(G) \leq \dots \leq \gamma_\Delta(G) < \gamma_{\Delta+1}(G) = |V|.$$

In the same work, Fink and Jacobson presented the following lower bounds for the  $k$ -domination number. Hereby, we call a bipartite graph  $G$   *$k$ -semiregular* if its vertex set can be bipartitioned in such a way that every vertex of one of the partite sets has degree  $k$ .

**Theorem 1.3** (Fink, Jacobson [27], 1985) *If  $G$  is a graph of order  $n$  and maximum degree  $\Delta$ , then*

$$\gamma_k(G) \geq \frac{k}{\Delta + k}n$$

for every integer  $k \in \mathbb{N}$ .

**Theorem 1.4** (Fink, Jacobson [28], 1985) *If  $G$  is a graph with  $n$  vertices and  $m$  edges, then*

$$\gamma_k(G) \geq n - \frac{m}{k}$$

for each  $k \geq 1$ . Furthermore, if  $m \neq 0$ , then  $\gamma_k(G) = n - \frac{m}{k}$  if and only if  $G$  is a  $k$ -semiregular graph.

In the same year as the publication of Fink and Jacobson, Cockayne, Gamble and Shepherd published a generalization of Ore's theorem for multiple domination.

**Theorem 1.5** (Cockayne, Gamble, Shepherd [20], 1985) *Let  $G$  be a graph of order  $n$  and minimum degree  $\delta$ . Then*

$$\gamma_k(G) \leq \frac{k}{k+1}n$$

for every integer  $k \leq \delta$ .

As the problem of finding a minimum dominating set, the problem of determining the  $k$ -domination number in an arbitrary graph has been shown by Jacobson and Peters [48] to be NP-hard. Therefore, we are interested in analyzing properties of the  $k$ -domination number with respect to other graph parameters which lead to good upper and lower bounds that help us to understand better this concept. This thesis handles with such questions and presents primarily the results on my investigations on  $k$ -domination of the past three years of my doctoral preparation, reviewing also several other important results on this topic that have been achieved over the years by other researchers.

### 1.3 Minimum $f$ -dominating sets in block graphs

As mentioned in the introduction, the problem of finding a minimum  $k$ -dominating set in a graph is NP-hard. However, for special graph classes, this

problem turns polynomial. This is the case of block graphs. In this section, we present an algorithm for finding a minimum  $f$ -dominating set in a block graph, which is a more general concept as the one of  $k$ -domination. Since trees are a special kind of block graphs, and since the  $k$ -domination generalizes the concept of the usual domination, this algorithm generalizes the one of Hedetniemi, Hedetniemi and Pfaff (see [45]) for minimum  $f$ -dominating sets in trees, the one of Jacobson and Peters for finding a minimum  $k$ -dominating set in a tree and the one of Volkmann [67] for minimum dominating sets in block graphs.

Let  $G$  be a graph with vertex set  $V$  and let  $f : V \rightarrow \{0, 1, \dots, k\}$  be a map on  $V$ . A subset  $D \subseteq V$  is called an  $f$ -dominating set of  $G$  if every vertex  $x \in V - D$  has at least  $f(x)$  neighbors in  $D$ . The cardinality of a minimum  $f$ -dominating set of  $G$  is the  $f$ -domination number and is denoted with  $\gamma_f(G)$ . Note that if  $f(x) = k$  for all  $x \in V$ , the  $f$ -dominating set corresponds with a  $k$ -dominating set of  $G$ .

The following theorem is the main tool of the algorithm.

**Theorem 1.6 (Reduction Theorem for Block Graphs)** *Let  $G$  be a block graph with vertex set  $V$  and let  $B$  be an end block of  $G$ . Let  $f : V \rightarrow \{0, 1, \dots, k\}$  be a map on  $V$  and set  $R := \{x \in V(B) \mid d_G(x) < f(x)\}$ .*

I. *Suppose that  $R \neq \emptyset$ . Let  $h : V - R \rightarrow \{0, 1, \dots, k\}$  be a map such that*

$$h(x) = \begin{cases} \max\{0, f(x) - |R|\}, & \text{if } x \in V(B), \\ f(x), & \text{otherwise.} \end{cases}$$

*If  $D$  is a minimum  $h$ -dominating set of  $H = G - R$ , then  $D \cup R$  is a minimum  $f$ -dominating set of  $G$ .*

II. *Suppose that  $R = \emptyset$  and that  $B$  has no cut vertex. Set  $l := \max_{x \in V(B)} f(x)$  and  $S = f^{-1}(l) \cap V(B)$ .*

(i) *If  $|S| \geq l$ , let  $H' = G - V(B)$  and  $h' = f|_{V(H')}$ . If  $D'$  is a minimum  $h'$ -dominating set of  $H'$ , then, for a subset  $U \subset V$  with  $|U| = l$ ,  $D' \cup U$  is a minimum  $f$ -dominating set of  $G$ .*

(ii) *If  $|S| < l$ , then define a map  $h'' : V - S \rightarrow \{0, 1, \dots, k\}$  such that  $h''(x) = \max\{0, f(x) - |S|\}$  for every  $x \in V(B) - S$  and  $h''(x) = f(x)$  for  $x \in V - V(B)$ . If  $D''$  is a minimum  $h''$ -dominating set of  $H'' = G - S$ , then  $D'' \cup S$  is a minimum  $f$ -dominating set of  $G$ .*

III. Suppose that  $R = \emptyset$  and that  $B$  has a cut vertex  $v$ . Set  $l' := \max\{f(x) \mid x \in V(B - v)\}$  and  $S' := f^{-1}(l') \cap V(B)$ .

(i) If  $l' = 0$  and  $D_1$  is a minimum  $h_1$ -dominating set of  $H_1 = G - V(B - v)$ , where  $h_1 = f|_{V(H_1)}$ , then  $D_1$  is also a minimum  $f$ -dominating set of  $G$ .

(ii) If  $s' = |S' - \{v\}| \geq l' > 0$ , let  $H_2 = G - V(B)$  and define a map  $h_2 : V(H_2) \rightarrow \{0, 1, \dots, k\}$  such that

$$h_2(x) = \begin{cases} \max\{0, f(x) - 1\}, & \text{if } x \in N_G(v) \\ f(x) & \text{otherwise.} \end{cases}$$

If  $D_2$  is a minimum  $h_2$ -dominating set of  $H_2$ , then

$$D_2 \cup W \cup \{v\}$$

is a minimum  $f$ -dominating set of  $G$  for each subset  $W \subseteq V(B) - \{v\}$  of cardinality  $l' - 1$ .

(iii) If  $s' = |S' - \{v\}| < l'$ , let  $H_3 = G - (S' - \{v\})$  and define a map  $h_3 := V(H_3) \rightarrow \{0, 1, \dots, k\}$  such that

$$h_3(x) = \begin{cases} \max\{0, f(x) - s'\}, & \text{if } x \in V(B) \\ f(x), & \text{otherwise.} \end{cases}$$

If  $D_3$  is a minimum  $h_3$ -dominating set of  $H_3$ , then

$$D_3 \cup (S' - \{v\})$$

is a minimum  $f$ -dominating set of  $G$ .

**Proof.** I. Suppose that  $|R| > 0$ . Let  $D_f$  be a minimum  $f$ -dominating set of  $G$ . Then it is evident that  $R \subseteq D_f$ . Let  $x \in (V(G) - D_f)$ . Then

$$\begin{aligned} |N_H(x) \cap (D_f - R)| &= |N_G(x) \cap D_f| - |N_G(x) \cap R| \\ &\geq \begin{cases} f(x) - |R|, & \text{if } x \in V(B) \\ f(x), & \text{otherwise} \end{cases} \\ &= h(x). \end{aligned}$$

Therefore,  $D_f - R$  is a  $h$ -dominating set of  $H$ . On the other side, since

$$\begin{aligned} |N_G(x) \cap (D \cup R)| &= |N_G(x) \cap D| + |N_G(x) \cap R| \\ &\geq \begin{cases} h(x) + |R|, & \text{if } x \in V(B) \\ h(x), & \text{otherwise} \end{cases} \\ &= f(x), \end{aligned}$$

$D \cup R$  is an  $f$ -dominating set of  $G$ . Thus, we obtain

$$\begin{aligned}\gamma_f(G) &\leq |D \cup R| = |D| + |R| = \gamma_h(H) \\ &\leq |D_f - R| + |R| = |D_f| = \gamma_f(G).\end{aligned}$$

II. Suppose that  $R = \emptyset$  and that  $B$  has no cut vertex. Then  $B$  is a component of  $G$  and  $B \cong K_n(B)$ . Let  $f_0 = f|_{V(B)}$ .

(i) Let  $x \in V(B) - U$ . Then  $|N_G(x) \cap U| = |U| = l \geq f_0(x)$  and thus  $U$  is an  $f_0$ -dominating set of  $B$ . Suppose there is a  $f_0$ -dominating set  $D_0$  of  $B$  with  $|D_0| < |U| = l$ . Then the set  $S - D_0$  is not empty and thus there is a vertex  $x \in S - D_0$  with  $|N_G(x) \cap D_0| \leq |D_0| < l = f_0(x)$ , which is a contradiction. It follows that  $U$  is a minimum  $f_0$ -dominating set of  $B$  and thus  $D' \cup U$  is a minimum  $f$ -dominating set of  $G$ .

(ii) Let  $x \in V(B) - (D'' \cup S)$ . Then

$$\begin{aligned}|N_G(x) \cap (D'' \cup S)| &= |N_G(x) \cap D''| + |S| \\ &= |N_{H''}(x) \cap D''| + |S| \\ &\geq h''(x) + |S| \geq f(x)\end{aligned}$$

and therefore  $D'' \cup S$  is an  $f$ -dominating set of  $G$ . Let  $D_f$  be a minimum  $f$ -dominating set of  $G$ . Suppose that there is a vertex  $x \in S - D_f$ . Then, obviously  $|D_f \cap V(B)| \geq l$  and thus there is a vertex  $y \in D_f \cap V(B) - S$ . Note that  $(D_f - \{y\}) \cup \{x\}$  is again an  $f$ -dominating set of  $G$ . Hence, we can assume that  $S \subseteq D_f$ . Now let  $u \in V(B) - (S \cup D_f)$ . It follows that

$$|N_{H''}(u) \cap (D_f - S)| = |N_G(u) \cap D_f| - |N_G(u) \cap S| \geq \max\{f(x) - |S|, 0\} = h(x).$$

Hence,  $D_f - S$  is an  $h''$ -dominating set of  $G - S$ . Altogether, we obtain

$$\gamma_f(G) \leq |D'' \cup S| = \gamma_{h''}(H'') + |S| \leq |D_f - S| + |S| = |D_f| = \gamma_f(G),$$

implying that  $D'' \cup S$  is a minimum  $f$ -dominating set of  $G$ .

III. Suppose that  $R = \emptyset$  and  $B$  has a cut vertex  $v$ . Let  $D_f$  be a minimum  $f$ -dominating set of  $G$ .

(i) Suppose that  $l = 0$ . Then  $|D_f \cap V(B)| \leq 1$ . If  $|D_f \cap V(B)| = 1$  we can suppose, without loss of generality, that  $v \in D_f$ . Then, if either  $|D_f \cap V(B)| = 1$  or  $D_f \cap V(B) = \emptyset$ ,  $D_f \subseteq V - V(B - v)$  holds and so  $D_f$  is evidently an  $h_1$ -dominating set of  $H_1$  and thus  $\gamma_{h_1}(H_1) \leq \gamma_f(G)$ . Obviously every  $h_1$ -dominating set of  $H_1$  is also an  $f$ -dominating set of  $G$  and so the statement follows.

(ii) Suppose that  $|S' - \{v\}| \geq l' > 0$ .

*Claim 1:*  $|V(B) \cap D_f| = l'$  and  $(D_f - \{x\}) \cup \{v\}$  is a minimum  $f$ -dominating set for every  $x \in V(B) \cap D_f$ .

Since  $D_f$  is a minimum  $f$ -dominating set of  $G$ , it follows from the definition of  $l'$  and because  $G$  is a block graph that  $|V(B) \cap D_f| \leq l'$ . If there is a vertex  $x \in S'$  such that  $x \notin D_f$ , then we obtain that  $|N(x) \cap D_f| \geq l'$  and so, since  $N(x) \subset V(B)$ , we have  $|V(B) \cap D_f| \geq l'$ . If  $S' \subseteq D_f$ , then  $|V(B) \cap D_f| \geq |S'| \geq l'$ . Thus  $|V(B) \cap D_f| = l'$ . Let  $y \in V - ((D_f - \{x\}) \cup \{v\})$ . If  $y \in V(B)$ , then  $|N(y) \cap ((D_f - \{x\}) \cup \{v\})| \geq l' \geq f(y)$ . If  $y \in V - V(B)$ , then  $|N(y) \cap ((D_f - \{x\}) \cup \{v\})| \geq |N(y) \cap D_f| \geq f(y)$ . Hence,  $(D_f - \{x\}) \cup \{v\}$  is also a minimum  $f$ -dominating set of  $G$  and so the claim is proved.

*Claim 2: If  $v \in D_f$ , then  $D_f - V(B)$  is a  $h_2$ -dominating set of  $H_2$ .*

Let  $x \in V - (D_f \cup V(B))$ . If  $x \in N(v)$ , then  $|N(x) \cap (D_f - V(B))| = |N(x) \cap (D_f - \{v\})| = |N(x) \cap D_f| - 1 \geq f(x) - 1 = h_2(x)$ . If  $x \in V - N(v)$ , then  $|N(x) \cap (D_f - V(B))| = |N(x) \cap D_f| \geq f(x) = h_2(x)$ . This implies that  $D_f - V(B)$  is a  $h_2$ -dominating set of  $H_2$ .

*Claim 3: If  $W$  is a subset of  $V(B) - \{v\}$  of order  $l - 1$ , then  $D_2 \cup W \cup \{v\}$  is an  $f$ -dominating set of  $G$ .*

Since  $D_2$  is a minimum  $h_2$ -dominating set of  $H_2$ ,  $|D_2 \cap N(x)| \geq h_2(x)$  holds for all  $x \in V - (D_2 \cup V(B))$ . Let  $x \in V - (D_2 \cup W \cup \{v\})$ . If  $x \in V(B)$ , then  $|N(x) \cap (D_2 \cup W \cup \{v\})| = |W \cup \{v\}| = l' \geq f(x)$  follows. If  $x \in N(v) - V(B)$  then  $|((D_2 \cup W \cup \{v\}) \cap N(x))| = |(D_2 \cup \{v\}) \cap N(x)| = |D_2 \cap N(x)| + 1 \geq h_2(x) + 1 = f(x)$ . If  $x \in V - N(v)$ , then  $|((D_2 \cup W \cup \{v\}) \cap N(x))| = |D_2 \cap N(x)| = h_2(x) = f(x)$ . Hence,  $D_2 \cup W \cup \{v\}$  is an  $f$ -dominating set of  $G$ .

Without lost of generality, because of Claim 1, we can suppose that  $v \in D_f$ . Together with Claims 1, 2 and 3, we can write the following inequality chain:

$$\begin{aligned} \gamma_f(G) &\leq |D_2 \cup W \cup \{v\}| = |D_2| + l' = \gamma_{h_2}(H_2) + l' \\ &\leq |D_f - V(B)| + l' = |D_f| = \gamma_f(G), \end{aligned}$$

implying that  $D_2 \cup W \cup \{v\}$  is a minimum  $f$ -dominating set of  $G$ .

(iii) Suppose that  $|S' - \{v\}| < l'$ .

*Claim 1: We can assume that  $S' - \{v\} \subseteq D_f$ .*

Suppose that there is a vertex  $x \in S' - (D \cup \{v\})$ . Then  $|N(x) \cap D| \geq l'$  and hence  $|(N(x) \cap D_f) - (S' \cup \{v\})| > 0$ . Thus there is a vertex  $y \in (N(x) \cap D_f) - (S' \cup \{v\})$ . For being  $G$  a block graph, it follows that  $|N(y) \cap ((D_f \cup \{x\}) - \{y\})| = |N(y) \cap D_f| + 1 = |N(x) \cap (D_f - \{y\})| + 1 = |N(x) \cap D_f| \geq l' \geq f(y)$ . Moreover, for every vertex  $z \in V - (D_f \cup \{x\})$  it holds that  $|N(z) \cap ((D_f \cup \{x\}) - \{y\})| = |N(z) \cap D_f| \geq f(z)$ . Thus  $D_f \cup \{x\} - \{y\}$  is a minimum  $f$ -dominating set of  $G$  containing  $x$ . So, we can assume that  $S' - \{v\} \subseteq D_f$ .

Thus without loss of generality, suppose that  $S' - \{v\} \subseteq D_f$ .

*Claim 2:*  $D_f - (S' - \{v\})$  is a  $h_3$ -dominating set of  $H_3$ .

Let  $x \in V(H_3) - (D_f - (S' - \{v\})) = V(H_3) - D_f$ . If  $x \in V(B)$ , then  $|N(x) \cap (D_f - (S' - \{v\}))| = |N(x) \cap D_f| - s' \geq f(x) - s' = h_3(x)$ . If  $x \notin V(B)$ , then  $|N(x) \cap (D_f - (S' - \{v\}))| = |N(x) \cap D_f| \geq f(x) = h_3(x)$ . Hence, the claim follows.

*Claim 3:* If  $D_3$  is a minimum  $h_3$ -dominating set of  $H_3$ , then  $D_3 \cup (S' - \{v\})$  is an  $f$ -dominating set of  $G$ .

Let  $x$  be a vertex in  $V - (D_3 \cup (S' - \{v\}))$ . If  $x \notin V(B)$ , then  $|N(x) \cap (D_3 \cup (S' - \{v\}))| = |N(x) \cap D_3| \geq h_3(x) = f(x)$ . If  $x \in V(B)$ , then  $|N(x) \cap (D_3 \cup (S' - \{v\}))| = |N(x) \cap D_f| + |N(x) \cap (S' - \{v\})| \geq h_3(x) + s' = f(x)$ . Thus,  $D_3 \cup (S' - \{v\})$  is an  $f$ -dominating set of  $G$ .

With Claims 1, 2 and 3 we obtain finally

$$\begin{aligned} \gamma_f(G) &\leq |D_3 \cup (S' - \{v\})| = |D_3| + |S' - \{v\}| = \gamma_{h_3}(H_3) + |S' - \{v\}| \\ &\leq |D_f - (S' - \{v\})| + |S' - \{v\}| = |D_f| = \gamma_f(G) \end{aligned}$$

and thus  $D_3 \cup (S' - \{v\})$  is a minimum  $f$ -dominating set of  $G$ .  $\square$

Having now the theoretical background, we can present the algorithm.

### Algorithm for finding a minimum $f$ -dominating set in a block graph

Let  $G$  be a block graph and let  $f : V(G) \rightarrow \{0, 1, \dots, k\}$  be a map on  $V(G)$ .

- 0) Set  $D := \emptyset$ ,  $H := G$ ,  $h := f$  and go to step 1.
- 1) If  $V(H) = \emptyset$ , then STOP. Otherwise, let  $B$  be an end block of  $H$  and go to step 2.
- 2) Set  $R := \{x \in V(B) \mid d_H(x) < h(x)\}$ . If  $R = \emptyset$  and  $B$  has no cut vertex, go to step 4. If  $R = \emptyset$  and  $B$  has a cut vertex  $v$ , go to step 5. Otherwise go to step 3.
- 3) Set

$$\begin{aligned} H &:= H - R, \\ h &: V(H) \rightarrow \{1, 2, \dots, k\}, \\ h(x) &:= \begin{cases} \max\{0, h(x) - |R|\}, & \text{if } x \in V(B), \\ h(x), & \text{otherwise,} \end{cases} \\ D &:= D \cup R \text{ and} \\ B &:= B - R. \end{aligned}$$

If  $V(B) = \emptyset$  or if  $B$  has a cut vertex  $v$  and  $V(B) - \{v\} = \emptyset$ , go to step 1. Otherwise go to step 2.

4) Set  $l := \max_{x \in V(B)} h(x)$  and  $S := h^{-1}(l) \cap V(B)$ .

*i.* If  $l \geq 0$  and  $|S| \geq l$ , then take a subset  $U \subset V(B)$  such that  $|U| = l$  and set:

$$\begin{aligned} H &:= H - V(B) \\ h &:= h|_{V(H)} \text{ and} \\ D &:= D \cup U \end{aligned}$$

and go to step 1.

*ii.* If  $|S| < l$ , then set:

$$\begin{aligned} H &:= H - S, \\ h &: V(H) \rightarrow \{1, 2, \dots, k\}, \\ h(x) &:= \begin{cases} \max\{0, h(x) - |S|\}, & \text{if } x \in V(B), \\ h(x), & \text{otherwise,} \end{cases} \\ D &:= D \cup S \text{ and} \\ B &:= B - S. \end{aligned}$$

If  $V(B) = \emptyset$  go to step 1, otherwise go to step 2.

5) Set  $l' := \max_{x \in V(B-v)} h(x)$  and  $S' := h^{-1}(l') \cap V(B)$ .

*i.* If  $l' = 0$ , then set:

$$\begin{aligned} H &:= H - V(B - v) \text{ and} \\ h &:= h|_{V - V(B-v)} \end{aligned}$$

and go to step 1.

*ii.* If  $l' > 0$  and  $|S' - \{v\}| \geq l'$ , take a subset  $W \subset V(B) - \{v\}$  such that  $|W| = l' - 1$  and set:

$$\begin{aligned} H &:= H - V(B) \\ h &: V(H) \rightarrow \{0, 1, \dots, p\}, \\ h(x) &:= \begin{cases} \max\{0, h(x) - 1\}, & \text{if } x \in N(v), \\ h(x), & \text{otherwise, and} \end{cases} \\ D &:= D \cup W \cup \{v\} \end{aligned}$$

and go to step 1.

iii. If  $s' = |S' - \{v\}| < l'$ , then set:

$$\begin{aligned} H &:= H - (S' - \{v\}), \\ h &: V(H) \rightarrow \{0, 1, \dots, p\}, \\ h(x) &:= \begin{cases} \max\{0, h(x) - s'\}, & \text{if } x \in V(B), \\ h(x), & \text{otherwise,} \end{cases} \\ D &:= D \cup (S' - \{v\}) \text{ and} \\ B &:= B - (S' - \{v\}). \end{aligned}$$

If  $V(B) = \emptyset$ , go to step 1. Otherwise go to step 2.

When the algorithm stops,  $V(H) = \emptyset$  and  $D$  is a minimum  $f$ -dominating set of  $G$ .

**Proof.** In every reduction step, the block  $B$  is reduced to a smaller block or it is removed from the graph. In the first case, the algorithm returns to step 2. In the second, it goes again to step 1. Since in every reduction step the graph  $H$  is always reduced to a graph with less vertices, in a finite number of steps  $V(H) = \emptyset$  and the algorithm stops. Note that steps 3, 4 and 5 correspond to parts I, II and III of Theorem 1.6, respectively. Therefore, since the emptyset is an  $h$ -dominating set for a graph without vertices and for the empty map  $h : \emptyset \rightarrow \{0, 1, \dots, k\}$ ,  $D$  is a minimum  $f$ -dominating set of  $G$  when  $V(H) = \emptyset$ .  $\square$

**Remark 1.7** For step (1) of the algorithm it is necessary to identify all cut vertices and blocks of the graph  $G$ . This can be done in  $\mathcal{O}(\max\{n, m\})$  steps (see for example [32], pp. 24 -27). All other steps are done in linear time. Since the whole procedure is repeated at most  $n$  times, the entire algorithm makes at most  $\mathcal{O}(n \max\{n, m\})$  steps until it stops.

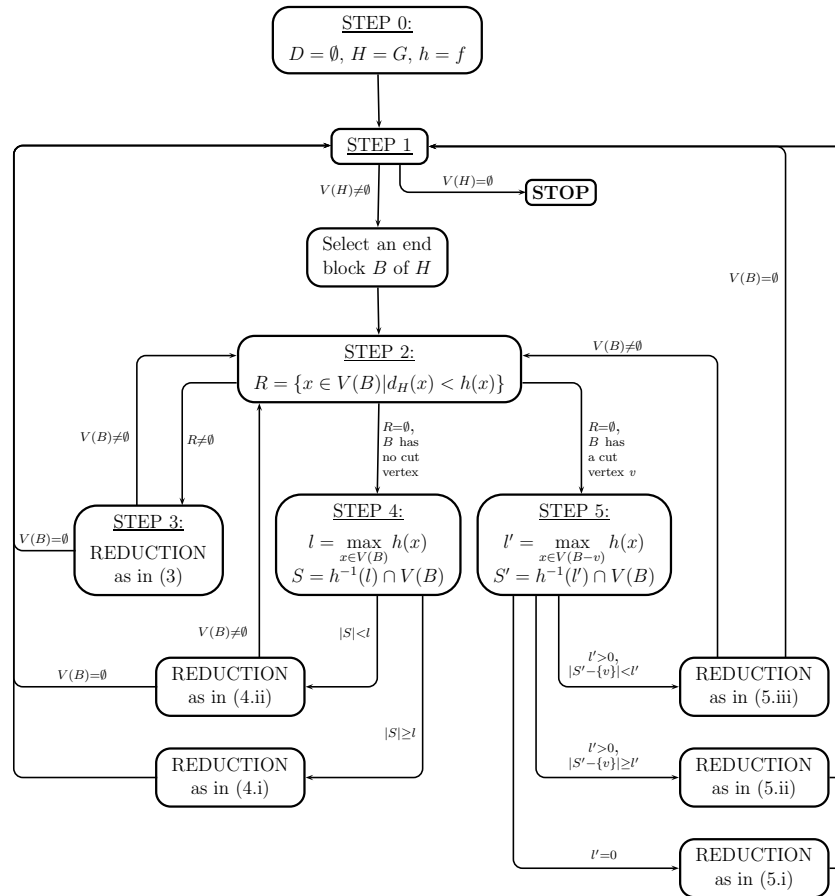

Figure 1.2: Sketch of the algorithm.



# Chapter 2

## Bounds on the $k$ -domination number

In this chapter, some new and some known bounds on the  $k$ -domination number are presented. Also, we analyze the structure of the extremal graphs.

### 2.1 An Erdős-type result and its applications

For a graph  $G$  with vertex set  $V$ , a subset  $I \subseteq V$  is called *independent* if the graph induced by  $I$  is empty. In [27, 28], Fink and Jacobson also generalized this concept by defining the  $k$ -dependence. Hereby,  $I$  is a  *$k$ -dependent set* if  $\Delta(G[I]) < k$ . The cardinality of a maximum  $k$ -dependent set is denoted with  $\alpha_k(G)$  and is called the  *$k$ -dependence number* of  $G$ . In the special case that  $k = 1$ , we set  $\alpha(G) = \alpha_1(G)$  and call it the *independence number* of  $G$ .

Next we will present a classical Erdős-type exchange argument in order to prove in a short and unique way some well-known results concerning  $k$ -domination and  $k$ -dependence. In particular, we will give proofs of theorems of Caro and Roditty and of Hopkins and Staton, who already used this principle in a similar way.

**Theorem 2.1** (Favaron, Hansberg, Volkmann [25], 2008) *Let  $G$  be a graph. If  $r \geq 1$  is an integer, then there is a partition  $V(G) = V_1 \cup V_2 \cup \dots \cup V_r$  of  $V(G)$  such that*

$$|N(u) \cap V_i| \leq \frac{d(u)}{r} \tag{2.1}$$

*for each  $i \in \{1, 2, \dots, r\}$  and each  $u \in V_i$ .*

**Proof.** Let  $V_1 \cup V_2 \cup \dots \cup V_r$  be a partition of  $V(G)$  such that the value  $\sum_{i=1}^r \sum_{u \in V_i} |N(u) \cap V_i|$  is minimum. Suppose that there is some index  $i_0 \in$

$\{1, 2, \dots, r\}$  and some  $u_0 \in V_{i_0}$  such that  $|N(u_0) \cap V_{i_0}| > \frac{d(u_0)}{r}$ . Then there exists some index  $i_1$  with  $1 \leq i_1 \leq r$  such that  $|N(u_0) \cap V_{i_1}| < \frac{d(u_0)}{r}$ . If  $V'_{i_0} = V_{i_0} - \{u_0\}$ ,  $V'_{i_1} = V_{i_1} \cup \{u_0\}$  and  $V'_t = V_t$  for  $1 \leq t \leq r$  with  $t \notin \{i_0, i_1\}$ , then

$$\begin{aligned} \sum_{i=1}^r \sum_{u \in V'_i} |N(u) \cap V'_i| &= \sum_{i=1}^r \sum_{u \in V_i} |N(u) \cap V_i| - 2|N(u_0) \cap V_{i_0}| + 2|N(u_0) \cap V_{i_1}| \\ &< \sum_{i=1}^r \sum_{u \in V_i} |N(u) \cap V_i|. \end{aligned}$$

This contradiction completes the proof of Theorem 1.  $\square$

Applying this theorem, we obtain a result of Caro and Roditty of the year 1990.

**Corollary 2.2** (Caro, Roditty [12], 1990) *If  $G$  is a graph, then, for every integer  $r \geq 1$ , there is a factor  $H$  of  $G$  such that  $rd_H(x) \geq (r-1)d_G(x)$  for all  $x \in V(G)$ .*

**Proof.** By Theorem 2.1, there is a partition  $V(G) = V_1 \cup V_2 \cup \dots \cup V_r$  of  $V(G)$  such that  $|N(u) \cap V_i| \leq \frac{d(u)}{r}$  for each  $i \in \{1, 2, \dots, r\}$  and each  $u \in V_i$ . Let  $H$  be the factor of  $G$  that remains by deleting all edges which are incident alone to vertices of  $V_i$  for each  $1 \leq i \leq r$ . Then, for  $x \in V_j$  and  $j \in \{1, 2, \dots, r\}$ ,

$$d_H(x) = d_G(x) - |N_G(x) \cap V_j| \geq \frac{r-1}{r}d_G(x). \quad \square$$

**Corollary 2.3** (Caro, Roditty [12], 1990) *Let  $r, k$  be positive integers and  $G$  a graph of order  $n$  and minimum degree  $\delta \geq (r+1)k/r - 1$ . Then*

$$\gamma_k(G) \leq \frac{r}{r+1}n.$$

**Proof.** Let  $r' = r + 1$  and let  $V_1, V_2, \dots, V_{r'}$  and  $H$  be like in Corollary 2.2 such that  $|V_1| \geq |V_2| \geq \dots \geq |V_{r'}|$ . Then, together with the hypothesis on  $\delta$ , it follows that  $d_H(x) \geq \frac{r'-1}{r'}d_G(x) = \frac{r}{r+1}d_G(x) \geq \frac{r}{r+1}\delta \geq k - \frac{r}{r+1}$  and hence, since  $d_H(x)$  is an integer,  $d_H(x) \geq k$  for all  $x \in V(G)$ . Thus,  $V - V_1$  is a  $k$ -dominating set of  $H$  and therefore

$$\gamma_k(G) \leq \gamma_k(H) \leq |V(G) - V_1| \leq n - \frac{n}{r'} = \frac{r}{r+1}n. \quad \square$$

This proof was the same given by Caro and Roditty and for reasons of completeness we presented it here again. An equivalent statement of Caro and Roditty's Theorem is the following corollary, which is some times better for applications.

**Corollary 2.4** (Favaron, Hansberg, Volkmann [25], 2008) *Let  $G$  be a graph of order  $n$  and minimum degree  $\delta$ . If  $k \leq \delta$  is an integer, then*

$$\gamma_k(G) \leq \frac{\lceil \frac{k}{\delta+1-k} \rceil}{\lceil \frac{k}{\delta+1-k} \rceil + 1} n.$$

**Proof.** Let  $r = \lceil \frac{\delta+1}{\delta+1-k} \rceil$  and let  $V_1, V_2, \dots, V_r$  be like in Theorem 2.1. Then inequality (2.1) leads to

$$|N(u) \cap V_i| \leq \frac{d(u)}{r} \leq \frac{\delta+1-k}{\delta+1} d(u)$$

for each  $i \in \{1, 2, \dots, r\}$  and each  $u \in V_i$ . Hence

$$d(u) - |N(u) \cap V_i| \geq d(u) - \frac{\delta+1-k}{\delta+1} d(u) = \frac{k d(u)}{\delta+1} \geq \frac{k \delta}{\delta+1} = k - \frac{k}{\delta+1}$$

and thus, with  $\frac{k}{\delta+1} < 1$ ,  $d(u) - |N(u) \cap V_i| \geq k$  for each  $i \in \{1, 2, \dots, r\}$  and each  $u \in V_i$ . So  $V(G) - V_i$  is a  $k$ -dominating set of  $G$  for each  $i \in \{1, 2, \dots, r\}$ . Since  $\max\{|V_i| : 1 \leq i \leq r\} \geq \frac{n}{r}$ , we deduce that

$$\gamma_k(G) \leq n - \frac{n}{r} = \frac{r-1}{r} n = \frac{\lceil \frac{k}{\delta+1-k} \rceil}{\lceil \frac{k}{\delta+1-k} \rceil + 1} n.$$

□

The bound of Caro and Roditty, although excellent, is not always easy to use because of its discontinuity and one can ask for a continuous explicit bound on  $\gamma_k(G)$  in terms of the minimum degree. This was first done by Stracke and Volkmann in 1993 [66] by introducing the new and more complex concept of  $f$ -dominating sets. Following the same idea, Chen and Zhou slightly improved their result and proved in 1998

**Theorem 2.5** (Chen, Zhou [17], 1998) *Let  $G$  be a graph of order  $n$  and minimum degree  $\delta \geq 5$ . Then*

$$\gamma_k(G) \leq \frac{2k - \delta - 1}{2k - \delta} n$$

for every integer  $k$  with  $(\delta+3)/2 \leq k \leq \delta-1$ .

In the next section we will give an improvement of this bound. But first, we want to present another application of Theorem 2.1 that leads to the following result of Hopkins and Staton, which will be later useful in this work.

**Corollary 2.6** (Hopkins, Staton [47], 1986) *Let  $G$  be a graph of order  $n$  and maximum degree  $\Delta$ . If  $k \geq 1$  is an integer, then*

$$\alpha_k(G) \geq \frac{n}{1 + \lfloor \frac{\Delta}{k} \rfloor}.$$

**Proof.** If  $r = 1 + \lfloor \frac{\Delta}{k} \rfloor$ , then inequality (2.1) leads to

$$|N(u) \cap V_i| \leq \frac{d(u)}{r} \leq \frac{\Delta}{1 + \lfloor \frac{\Delta}{k} \rfloor} < k$$

and thus  $|N(u) \cap V_i| \leq k - 1$  for each  $i \in \{1, 2, \dots, r\}$  and each  $u \in V_i$ . Therefore, each  $V_i$  is a  $k$ -dependent set of  $G$  for  $1 \leq i \leq r$ . Since

$$\alpha_k(G) \geq \max\{|V_i| : 1 \leq i \leq r\} \geq \frac{n}{r},$$

the desired bound follows. □

## 2.2 On $k$ -domination and minimum degree

Now we will present some new bounds of the  $k$ -domination number in terms of order and minimum degree. Corollary 2.4 leads to the next result.

**Corollary 2.7** (Favaron, Hansberg, Volkmann [25], 2008) *Let  $G$  be a graph of order  $n$  and minimum degree  $\delta$ . If  $k \leq \delta$  is an integer, then*

$$\gamma_k(G) \leq \frac{\delta}{2\delta + 1 - k}n.$$

**Proof.** Since  $\lceil \frac{a}{b} \rceil \leq \frac{a+b-1}{b}$  for positive integers  $a$  and  $b$  and since the function  $\frac{x}{x+1}$  is increasing for  $x$  positive, Corollary 2.4 implies

$$\gamma_k(G) \leq \frac{\lceil \frac{k}{\delta+1-k} \rceil}{\lceil \frac{k}{\delta+1-k} \rceil + 1}n \leq \frac{\frac{\delta}{\delta+1-k}}{\frac{\delta}{\delta+1-k} + 1}n = \frac{\delta}{2\delta + 1 - k}n.$$

□

A simple calculation yields

$$\frac{\delta}{2\delta + 1 - k} \leq \frac{2k - \delta - 1}{2k - \delta}$$

for  $(\delta + 4)/2 \leq k \leq \delta - 1$  and thus  $\delta \geq 6$ . This shows that the bound in Corollary 2.7 is better than the one by Chen and Zhou in Theorem 2.5 for the case that  $(\delta + 4)/2 \leq k \leq \delta - 1$  and  $\delta \geq 6$ . For the remaining case that  $k = \frac{\delta+3}{2}$ , since  $\frac{\delta+3}{2} \leq \frac{2\delta+2}{3}$  for  $\delta \geq 3$ , Corollary 2.4 leads to the bound  $\gamma_k(G) \leq \frac{2}{3}n$  of Chen and Zhou.

**Theorem 2.8** (Favaron, Hansberg, Volkmann [25], 2008) *Every graph of order  $n$  and minimum degree  $\delta$  satisfies*

$$\gamma_k(G) + \frac{(k' - k + 1)}{2k' - k} \gamma_{k'}(G) \leq n$$

for all integers  $k$  and  $k'$  with  $1 \leq k \leq k' \leq \delta$ .

**Proof.** Let  $H$  be a spanning subgraph of  $G$  of minimum degree  $k'$  and minimal for this property. Since  $\gamma_j(G - e) \geq \gamma_j(G)$  for any edge  $e$  of  $G$  and any positive integer  $j$ ,  $\gamma_j(H) \geq \gamma_j(G)$ . By the minimality of  $H$ , the set  $A$  of vertices of  $H$  of degree more than  $k'$  is independent or empty. Let  $B$  be a maximal independent set of  $H$  containing  $A$  and let  $U = V - B$ . Since every vertex of  $U$  has degree  $k'$  in  $H$ , and at least one neighbor in  $B$ ,

$$\Delta_H(U) \leq k' - 1. \quad (2.2)$$

Moreover the set  $U$  is  $k'$ -dominating in  $H$  and thus

$$|U| \geq \gamma_{k'}(H). \quad (2.3)$$

By Corollary 2.6, (2.2) and (2.3), the  $(k' - k + 1)$ -dependence number of  $H[U]$  satisfies

$$\alpha_{k'-k+1}(U) \geq \frac{|U|}{1 + \lfloor \frac{\Delta(U)}{k'-k+1} \rfloor} \geq \frac{\gamma_{k'}(H)}{1 + \lfloor \frac{k'-1}{k'-k+1} \rfloor} \geq \frac{\gamma_{k'}(H)(k' - k + 1)}{2k' - k}. \quad (2.4)$$

Let  $W$  be a maximum  $(k' - k + 1)$ -dependent set of  $H[U]$ . Every vertex  $x$  in  $W$  has at most  $k' - k$  neighbors in  $W$ , and thus at least  $k$  neighbors in  $V - W$ . Therefore,  $V - W$  is a  $k$ -dominating set of  $H$  and

$$|V - W| \geq \gamma_k(H) \quad (2.5)$$

Therefore, by (2.4) and (2.5),

$$\gamma_k(H) \leq n - \alpha_{k'-k+1}(U) \leq n - \frac{\gamma_{k'}(H)(k' - k + 1)}{2k' - k}.$$

Hence  $\gamma_k(H) + \frac{k' - k + 1}{2k' - k} \gamma_{k'}(H) \leq n$  and since  $\gamma_k(G) \leq \gamma_k(H)$  and  $\gamma_{k'}(G) \leq \gamma_{k'}(H)$ , the same inequality holds for  $G$ .  $\square$

As well as Corollaries 2.3 and 2.4, this theorem yields Theorem 1.5 of Cockayne, Gamble and Shepherd by setting  $k' = k$ . We give it here again as a corollary.

**Corollary 2.9** (Cockayne, Gamble, Shepherd [20], 1985) *Let  $G$  be a graph of order  $n$  and minimum degree  $\delta$ . Then*

$$\gamma_k(G) \leq \frac{k}{k+1}n$$

for every integer  $k \leq \delta$ .

Moreover, we can use Theorem 2.4 in order to characterize the graphs satisfying equality in Corollary 2.9.

**Theorem 2.10** (Favaron, Hansberg, Volkmann [25], 2008) *Let  $G$  be a connected graph of order  $n$  and minimum degree  $\delta$ . Then  $G$  satisfies  $\gamma_k(G) = \frac{k}{k+1}n$  for some integer  $k$  with  $1 \leq k \leq \delta$  if and only if  $G$  is the corona  $J \circ K_k$ , when  $k \geq 2$ , and  $J \circ K_1$  or  $G \cong C_4$ , when  $k = 1$ , where  $J$  is any connected graph.*

**Proof.** If  $G$  is isomorphic to the cycle  $C_4$ , it follows that  $\gamma(G) = 2 = n/2$ . If  $G = J \circ K_k$ , then the vertices not in  $J$  form a  $k$ -dominating set and each  $k$ -dominating set must have at least  $k$  vertices in each clique  $K_{k+1}$  with one vertex in  $J$ . Therefore  $\gamma_k(G) = k|V(J)| = k\frac{n}{k+1}$ .

We prove the converse. With  $k' = k$  we have equality in the whole proof of Theorem 2.8. Following the proof of this theorem, we obtain  $\Delta(H[U]) = k - 1$  and  $\beta(H[U]) = \frac{|U|}{1 + \Delta(H[U])}$ , which implies that  $U$  consists of, say,  $p$  disjoint cliques  $C_1, C_2, \dots, C_p$  isomorphic to  $K_k$  (see for instance chap. 13 in [5]). Then  $|U| = pk$  and  $W$  contains exactly one vertex of each clique  $C_1, C_2, \dots, C_p$ , which implies  $|W| = p$ ,  $|U - W| = (k-1)p$  and  $|V - W| = n - p$ . Because of the equalities in (2.3) and (2.5) of Theorem 2.8,  $U$  and  $V - W$  have to be both  $\gamma_k(G)$ -sets and thus  $pk = n - p$ . It follows that  $p = n/(k+1)$  and that  $|B| = n - |U| = p(k+1) - pk = p = |W|$ . Each vertex of  $U$  has

degree  $k$  in  $H$  and thus has exactly one neighbor in  $B$ . Since each vertex in  $B$  has degree at least  $k$  in  $H$  we obtain  $pk \leq m_H(B, U) = m_H(U, B) = pk$  and so  $H$  is  $k$ -regular and the set  $A$  of vertices with degree greater than  $k$  is empty, which implies that  $B$  is an arbitrary maximum independent set of  $H$ .

We will now show that each vertex of  $B$  is adjacent to exactly all vertices of one of the cliques of  $H[U]$  in  $H$ . Suppose there is a vertex  $v \in B$  which is adjacent to two vertices  $x_1 \in V(C_1)$  and  $x_2 \in V(C_2)$  of two different cliques  $C_1$  and  $C_2$  of  $H[U]$ . Since  $x_1$  and  $x_2$  cannot be adjacent to other vertices in  $B$  for having already  $k - 1$  neighbors in  $U$ , the set  $(B - \{v\}) \cup \{x_1, x_2\}$  is an independent set of  $H$  greater than  $B$ , which is a contradiction. It follows that  $v$  can only have neighbors in one clique of  $H[U]$ . Since  $H$  is  $k$ -regular, each vertex  $v_i$  of  $B = \{v_1, v_2, \dots, v_p\}$  has to be adjacent to all vertices of a particular clique  $C_i$  of  $H[U]$  and thus  $H$  is the disjoint union of  $p$  cliques  $L_1, L_2, \dots, L_p$  isomorphic to  $K_{k+1}$ .

When  $p \geq 2$ , it remains to see which edges can be added to  $H$  to construct a connected graph  $G$  keeping the property  $\gamma_k(G) = kn/(k + 1)$ . We call red the edges of  $G - H$  and their end vertices. Suppose two different vertices  $x$  and  $y$  of some clique  $L_i$ , say  $L_1$ , are red and let  $x'$  and  $L(x')$  ( $y'$  and  $L(y')$  respectively) be a red neighbor of  $x$  ( $y$ ) and the clique of  $H$  containing  $x'$  ( $y'$ ).

Assume first that  $k = 1$ ,  $x' \neq y'$  and  $L(x') = L(y')$ . Then the vertices  $x', x, y, y'$  form a cycle of length 4. If there would be more edges than these four, say  $x$  would be adjacent to a vertex  $w$  (which can also be  $y'$ ), then we could construct a dominating set with exactly one vertex of each clique  $L_i$  for  $i \geq 2$ , among them  $w$  and  $y'$ , and  $\gamma(G) \leq p - 1 = n/2 - 1$ , which is a contradiction. Thus, since  $G$  is connected, there can neither be more vertices nor more edges in  $G$  and so  $G$  is isomorphic to the cycle  $C_4$ .

Now suppose that  $k \geq 2$  or that  $k = 1$  and  $x' = y'$  or  $L(x') \neq L(y')$ . Then we can construct a  $k$ -dominating set by taking  $L_1 - \{x, y\}$  and  $k$  vertices in each  $L_i$  for  $i \geq 2$ , among them  $x'$  in  $L(x')$  and  $y'$  in  $L(y')$  (note that this construction includes the particular cases  $x' = y'$  and  $x' \neq y'$  but  $L(x') = L(y')$ ). Hence,  $\gamma_k(G) \leq k(p - 1) + k - 1 = kn/(k + 1) - 1$ , a contradiction. Since  $G$  is connected, this means that there is exactly one red vertex in each clique  $L_i$  for  $1 \leq i \leq p$  and that the red vertices form a connected graph  $J$  and so  $G$  is isomorphic to the  $K_k$ -corona graph of  $J$ .  $\square$

Cockayne, Gamble and Shepherd's bound is given for graphs with minimum degree  $\delta \geq k$ . Under the stronger assumption on the minimum degree that  $\sqrt{\ln \delta} > k$ , Caro and Yuster [14] gave an upper bound of the form of  $(1 + o_\delta(1)) \frac{n \ln \delta}{\delta}$  for the minimum cardinality of an  $(F, k)$ -core, which is a more general concept for a  $k$ -dominating set. Weakening considerably the

condition on the minimum degree, Rautenbach and Volkmann presented the following upper bound on the  $k$ -domination number  $\gamma_k$ . Due to the weaker conditions, this bound is as expected not as strong as the previous mentioned bounds.

**Theorem 2.11** (Rautenbach, Volkmann [61], 2007) *Let  $G$  be a graph on  $n$  vertices with minimum degree  $\delta \geq 1$  and let  $k \in \mathbb{N}$ . If  $\frac{\delta+1}{\ln(\delta+1)} \geq 2k$ , then*

$$\gamma_k(G) \leq \frac{n}{\delta+1} \left( k \ln(\delta+1) + \sum_{i=0}^{k-1} \frac{1}{i! (\delta+1)^{k-1-i}} \right).$$

Following the same probabilistic method as in [61] (see also [2]), we will present two new bounds for the  $k$ -domination number  $\gamma_k$ . The first one is shown using the same method as in the proof of Theorem 2.11, changing only the construction of the  $k$ -dominating set. Note that even though it preserves the same assumptions, the achieved bound is better. Moreover, we obtain as a corollary a well-known bound for the usual domination number of Arnautov [3], Lovász [52] and Payan [57]. The second one weakens a little more the assumption on the minimum degree  $\delta$  and, for  $k \geq 3$ , it is even better than the previous one.

**Theorem 2.12** (Hansberg, Volkmann [41], 2009) *Let  $G$  be a graph on  $n$  vertices with minimum degree  $\delta \geq 1$  and let  $k \in \mathbb{N}$ . If  $\frac{\delta+1}{\ln(\delta+1)} \geq 2k$ , then*

$$\gamma_k(G) \leq \frac{n}{\delta+1} \left( k \ln(\delta+1) + \sum_{i=0}^{k-1} \frac{\delta^i}{i! (\delta+1)^{k-1}} \right).$$

**Proof.** Let  $2k \leq \frac{\delta+1}{\ln(\delta+1)}$  and define  $p = \frac{k \ln(\delta+1)}{\delta+1}$ . The condition on  $\delta$  implies that  $p \leq \frac{1}{2}$ . Also, it implies that  $\delta \geq k$ . This can be shown assuming by contradiction that  $\delta \leq k-1$ . Since the function  $h(x) = \frac{x}{\ln x}$  is monotonically increasing for  $x > e$  and  $h(2) = h(4)$ , we obtain that  $h(x) \leq h(y)$  for integers  $y \geq x \geq 2$ , except for the case that  $x = 2$  and  $y = 3$ . Thus, when  $\delta \neq 1$  or  $k \neq 3$ , it follows that

$$2k \leq \frac{\delta+1}{\ln(\delta+1)} \leq \frac{k}{\ln k},$$

which leads to the contradiction  $k \leq \sqrt{e}$ . If  $\delta = 1$  and  $k = 3$ , evidently  $2k \leq \frac{\delta+1}{\ln(\delta+1)}$  is not fulfilled and we are done.

Now we select a set of vertices  $A \subseteq V(G)$  independently at random with  $P(v \in A) = p$ . Let  $B$  be the set of vertices of  $V(G) - A$  with less than

$k$  neighbors in  $A$ . Then  $A \cup B$  is a  $k$ -dominating set of  $G$ . We will now determine  $P(v \in B)$ .

$$\begin{aligned}
P(v \in B) &= P(|N(v) \cap A| \leq k-1, v \notin A) \\
&= \sum_{i=0}^{k-1} P(|N(v) \cap A| = i)(1-p) \\
&= \sum_{i=0}^{k-1} \binom{d(v)}{i} p^i (1-p)^{d(v)-i+1} \\
&= \sum_{i=0}^{k-1} \binom{d(v)}{i} \left(\frac{p}{1-p}\right)^i (1-p)^{d(v)+1} \\
&\leq \sum_{i=0}^{k-1} \binom{d(v)}{i} (1-p)^{d(v)+1} \\
&\leq \sum_{i=0}^{k-1} \frac{d(v)^i}{i!} (1-p)^{d(v)+1}.
\end{aligned}$$

Let  $f_i(d(v)) = -p(d(v) + 1) + i \ln(d(v))$ . Then

$$\frac{\partial f_i}{\partial d(v)}(-p(d(v) + 1) + i \ln(d(v))) = -p + \frac{i}{d(v)} \leq -p + \frac{k-1}{\delta}.$$

Since  $\delta \geq k$ , it is a simple matter to check that  $\frac{k}{\delta+1} \geq \frac{k-1}{\delta}$ . Thus, if  $\delta \geq 2$ , we obtain  $\ln(\delta+1) \frac{k}{\delta+1} \geq \frac{k-1}{\delta}$ . In the case that  $\delta = 1$ , it follows that  $k = 1$  and the inequality  $\ln(\delta+1) \frac{k}{\delta+1} \geq \frac{k-1}{\delta}$  is trivial. Hence,

$$\frac{\partial f_i}{\partial d(v)}(-p(d(v) + 1) + i \ln(d(v))) \leq -p + \frac{k-1}{\delta} = -\frac{k \ln(\delta+1)}{\delta+1} + \frac{k-1}{\delta} \leq 0$$

and thus  $f_i(d(v))$  is monotonically decreasing. Together with  $1-x \leq e^{-x}$  for  $x \in [0, 1]$ , this implies

$$\begin{aligned}
P(v \in B) &\leq \sum_{i=0}^{k-1} \frac{1}{i!} e^{-p(d(v)+1) + i \ln(d(v))} \\
&\leq \sum_{i=0}^{k-1} \frac{1}{i!} e^{-p(\delta+1) + i \ln(\delta)} \\
&= \sum_{i=0}^{k-1} \frac{1}{i!} e^{-k \ln(\delta+1) + i \ln(\delta)} \\
&= \sum_{i=0}^{k-1} \frac{1}{i!} \frac{\delta^i}{(\delta+1)^k}.
\end{aligned}$$

Hence we obtain finally

$$\begin{aligned}\gamma_k(G) &\leq E[A \cup B] = E[|A|] + E[|B|] \\ &\leq n \frac{k \ln(\delta + 1)}{\delta + 1} + n \sum_{i=0}^{k-1} \frac{\delta^i}{i! (\delta + 1)^k} \\ &= \frac{n}{\delta + 1} \left( k \ln(\delta + 1) + \sum_{i=0}^{k-1} \frac{\delta^i}{i! (\delta + 1)^{k-1}} \right).\end{aligned}$$

□

**Corollary 2.13** (Hansberg, Volkmann [41], 2009) *Let  $G$  be a graph on  $n$  vertices with minimum degree  $\delta \geq 1$  and let  $k \in \mathbb{N}$ . If  $\frac{\delta+1}{\ln(\delta+1)} \geq 2k$ , then*

$$\gamma_k(G) \leq \frac{n}{\delta + 1} (k \ln(\delta + 1) + 1).$$

**Proof.** Using  $\sum_{i=0}^{k-1} \delta^i \leq (\delta + 1)^{k-1}$ , it follows that

$$\sum_{i=0}^{k-1} \frac{1}{i!} \frac{\delta^i}{(\delta + 1)^{k-1}} \leq \frac{1}{(\delta + 1)^{k-1}} \sum_{i=0}^{k-1} \delta^i \leq 1$$

and hence Theorem 2.12 implies

$$\begin{aligned}\gamma_k(G) &\leq \frac{n}{\delta + 1} \left( k \ln(\delta + 1) + \sum_{i=0}^{k-1} \frac{\delta^i}{i! (\delta + 1)^{k-1}} \right) \\ &\leq \frac{n}{\delta + 1} (k \ln(\delta + 1) + 1).\end{aligned}$$

□

For the case  $k = 1$ , we obtain directly the above mentioned bound for the usual domination number  $\gamma$ , which was proved independently by Arnautov in 1974 and in 1975 by Lovász and by Payan.

**Corollary 2.14** (Arnautov [3] 1974, Lovász [52], Payan [57] 1975) *If  $G$  is a graph on  $n$  vertices with minimum degree  $\delta \geq 1$ , then*

$$\gamma(G) \leq \frac{n}{\delta + 1} (\ln(\delta + 1) + 1).$$

For the second bound we use a slightly different probability  $p$  as in Theorem 2.12.

**Theorem 2.15** (Hansberg, Volkmann [41], 2009) *Let  $G$  be a graph on  $n$  vertices with minimum degree  $\delta \geq k$ , where  $k \in \mathbb{N}$ . If  $\frac{\delta+1+2\ln(2)}{\ln(\delta+1)} \geq 2k$  then*

$$\gamma_k(G) \leq \frac{n}{\delta+1} \left( k \ln(\delta+1) - \ln(2) + 2 \sum_{i=0}^{k-1} \frac{\delta^i}{i! (\delta+1)^{k-1}} \right).$$

**Proof.** Let  $2k \leq \frac{\delta+1+2\ln(2)}{\ln(\delta+1)}$  and define  $p = \frac{k \ln(\delta+1) - \ln(2)}{\delta+1}$ . The condition on  $\delta$  implies that  $p \leq \frac{1}{2}$ . We select a set of vertices  $A \subseteq V(G)$  independently at random with  $P(v \in A) = p$ . Let  $B$  be the set of vertices of  $V(G) - A$  with less than  $k$  neighbors in  $A$ . Then  $A \cup B$  is a  $k$ -dominating set of  $G$  and  $f = (V(G) - (A \cup B), B, A)$  is a  $k$ -Roman domination function for  $G$ . It is easy to see that  $-p + \frac{k-1}{\delta} \leq 0$  when  $k = 1$ . Since  $p \leq \frac{1}{2}$ , the case  $\delta = k = 2$  has not to be considered. For the case that  $\delta \geq 3$  and  $k \geq 2$ , note that the inequality  $-p + \frac{k-1}{\delta} \leq 0$  is equivalent to

$$k \left( \frac{\delta+1}{\delta} - \ln(\delta+1) \right) \leq \frac{\delta+1}{\delta} - \ln(2),$$

which is obviously true, since the expression on the left is negative and the one on the right positive for  $\delta \geq 3$  and  $k \geq 2$ . Altogether it follows for any  $\delta \geq k \geq 1$  that  $-p + \frac{k-1}{\delta} \leq 0$  and hence, as in the proof of Theorem 2.12, we have

$$P(v \in B) \leq \sum_{i=0}^{k-1} \frac{1}{i!} e^{-p(\delta+1)+i \ln(\delta)}.$$

Thus, we obtain in this case

$$P(v \in B) \leq \sum_{i=0}^{k-1} \frac{1}{i!} e^{-k \ln(\delta+1) + \ln(2) + i \ln(\delta)} = \sum_{i=0}^{k-1} \frac{2 \delta^i}{i! (\delta+1)^k}.$$

This implies

$$\begin{aligned} \gamma_k(G) &\leq E[|A \cup B|] = E[|A|] + E[|B|] \\ &\leq n \left( \frac{k \ln(\delta+1) - \ln(2)}{\delta+1} \right) + n \sum_{i=0}^{k-1} \frac{2 \delta^i}{i! (\delta+1)^k} \\ &= \frac{n}{\delta+1} \left( k \ln(\delta+1) - \ln(2) + 2 \sum_{i=0}^{k-1} \frac{\delta^i}{i! (\delta+1)^{k-1}} \right) \end{aligned}$$

and we are done.  $\square$

Although the condition on  $\delta$  in this theorem is weaker as in Theorem 2.12, for  $k \geq 3$ , the bound for  $\gamma_k$  given here is even better as the former one. This can be seen the following way. We want to show that for  $k \geq 3$

$$2 \sum_{i=0}^{k-1} \frac{\delta^i}{i! (\delta + 1)^{k-1}} - \ln(2) \leq \sum_{i=0}^{k-1} \frac{\delta^i}{i! (\delta + 1)^{k-1}}.$$

This is equivalent to prove that

$$\sum_{i=0}^{k-1} \frac{\delta^i}{i!} \leq \ln(2)(\delta + 1)^{k-1} = \ln(2) \sum_{i=0}^{k-1} \binom{k-1}{i} \delta^i$$

or rather that

$$1 - \ln(2) \leq \sum_{i=1}^{k-1} \left( \ln(2) \binom{k-1}{i} - \frac{1}{i!} \right) \delta^i. \quad (2.6)$$

Note that, considering  $k \geq 3$ , the coefficients of the sum given in (2.6) are always positive. Thus, using  $\delta \geq 1$ , it is easy to see that

$$\begin{aligned} \sum_{i=1}^{k-1} \left( \ln(2) \binom{k-1}{i} - \frac{1}{i!} \right) \delta^i &\geq \sum_{i=1}^{k-1} \left( \ln(2) \binom{k-1}{i} - \frac{1}{i!} \right) \\ &\geq \ln(2)(k-1) - 1 \\ &\geq 1 - \ln(2) \end{aligned}$$

and therefore (2.6) is proved.

The following observation shows that, for  $k \geq 4$ , Corollary 2.13 can be improved.

**Observation 2.16** (Hansberg, Volkmann [41], 2009) *Let  $k \geq 4$  be an integer and  $G$  a graph of minimum degree  $\delta \geq k$ .*

(i) *If  $2k \leq \frac{\delta+1}{\ln(\delta+1)}$ , then*

$$\gamma_k(G) \leq \frac{n}{\delta + 1} \left( k \ln(\delta + 1) + 1 - \frac{k-1}{\delta} \right).$$

(ii) If  $\frac{\delta+1+2\ln(2)}{\ln(\delta+1)} \geq 2k$ , then

$$\gamma_k(G) \leq \frac{n}{\delta+1} \left( k \ln(\delta+1) - \ln(2) + 2 - 2\frac{k-1}{\delta} \right).$$

**Proof.** Due to Theorems 2.12 and 2.15, we only have to show that, for  $k \geq 4$ ,

$$\sum_{i=0}^{k-1} \frac{\delta^i}{i! (\delta+1)^{k-1}} \leq 1 - \frac{k-1}{\delta}.$$

If  $\delta \geq k = 4$ , it is easy to check this property. If  $\delta \geq k \geq 5$ , it follows by the induction hypothesis that

$$\begin{aligned} \sum_{i=0}^k \frac{\delta^i}{i! (\delta+1)^k} &= \frac{1}{\delta+1} \left( \frac{\delta^k}{(\delta+1)^{k-1} k!} + \sum_{i=0}^{k-1} \frac{\delta^i}{i! (\delta+1)^{k-1}} \right) \\ &\leq \frac{1}{\delta+1} \left( \frac{\delta^k}{(\delta+1)^{k-1} k!} + 1 - \frac{k-1}{\delta} \right). \end{aligned}$$

Thus, it remains to show that

$$\frac{\delta^k}{(\delta+1)^k k!} + \frac{1}{\delta+1} \left( 1 - \frac{k-1}{\delta} \right) \leq 1 - \frac{k-1}{\delta}.$$

Since  $\frac{\delta^k}{(\delta+1)^k} \leq \frac{\delta}{\delta+1}$ , it is enough to show that

$$\frac{\delta}{(\delta+1) k!} + \frac{1}{\delta+1} \left( 1 - \frac{k-1}{\delta} \right) \leq 1 - \frac{k-1}{\delta},$$

which is equivalent to

$$\delta \leq (\delta - k + 1)k!.$$

From the fact that  $\delta \leq (\delta - k + 1)k$ , which is straightforward to prove, this last inequality follows immediately and the proof is complete.  $\square$

Note that for  $k = 3$ , instead of the term  $\frac{k-1}{\delta}$  of previous observation, we can set everywhere the term  $\frac{k-2}{\delta}$  and we obtain for this case a better result as in Corollary 2.13, too.

## 2.3 On $k$ -domination and usual domination

Let  $G$  be a graph such that  $2 \leq k \leq \Delta(G)$  for an integer  $k$ . Then  $V - D$  is not empty and we can take a vertex  $x \in V - D$ . If  $X \subseteq N_G(x) \cap D$  is a set of neighbors of  $x$  in  $D$  such that  $|X| = k - 1$ , then evidently every vertex in  $V - ((D - X) \cup \{x\})$  has a neighbor in  $(D - X) \cup \{x\}$  and thus the latter is a dominating set of  $G$ . This implies the following theorem of Fink and Jacobson, which establishes a relation between the usual domination number  $\gamma(G)$  and the  $k$ -domination number  $\gamma_k(G)$ .

**Theorem 2.17** (Fink, Jacobson [27], 1985) *If  $k \geq 2$  is an integer and  $G$  is a graph with  $k \leq \Delta(G)$ , then*

$$\gamma_k(G) \geq \gamma(G) + k - 2. \quad (2.7)$$

In this section, we will deal with analyzing the structure of the graphs satisfying equality in this bound. Although the proof of the bound is very easy, the characterization of the extremal graphs seems to be an extremely difficult problem. The first part of this section presents some properties for the graphs  $G$  with  $\gamma_k(G) = \gamma(G) + k - 2$ , in the second one we concentrate on the special case  $k = 2$  and give some characterizations of different graph classes achieving equality.

### 2.3.1 Properties of the extremal graphs

Next theorem gives a property for graphs achieving equality in (2.7) with respect to the concept of  $k$ -dependence.

**Theorem 2.18** (Hansberg [34]) *Let  $G$  be a connected graph and  $k$  an integer with  $\Delta(G) \geq k \geq 2$ . If  $\gamma_k(G) = \gamma(G) + k - 2$  and  $D$  is a minimum  $k$ -dominating set, then  $D$  is a  $(k - 1)$ -dependent set of  $G$  and thus  $\gamma_k(G) \leq \alpha_{k-1}(G)$ .*

**Proof.** Suppose that there is a vertex  $x \in D$  such that  $|N_G(x) \cap D| \geq k - 1$ . Let  $S$  be a subset of  $N_G(x) \cap D$  with  $|S| = k - 1$ . Since every vertex in  $V - D$  has at least one neighbor in  $D - S$  and the vertices of  $S$  are dominated by  $x$  in  $D - S$ ,  $D - S$  is a dominating set of  $G$  with  $\gamma_k(G) - k + 1$  vertices, a contradiction to the hypothesis that  $\gamma_k(G) = \gamma(G) + k - 2$ . Thus, the statement follows.  $\square$

**Corollary 2.19** *If  $G$  is a connected graph with  $\gamma_2(G) = \gamma(G)$ , then every minimum 2-dominating set is independent.*

In the following, we will analyze the structure of the graphs satisfying equality in (2.7) with respect to the induced cycles of length four contained in them. As we shall see, the cycle  $C_4$  plays an important role in this matter. The following lemma will be an important tool for the next theorems.

**Lemma 2.20** (Chellali, Favaron, Hansberg, Volkmann [16]) *Let  $G$  be a non-trivial graph of order  $n$  such that  $m(\overline{G}) \leq n - 2$  and  $\Delta(G) \leq n - 2$ . Then  $m(\overline{G}) \geq \lceil \frac{n}{2} \rceil$  and  $G$  contains at least  $m(\overline{G}) - 1$  induced cycles of length 4.*

**Proof.** Let  $q = m(\overline{G})$ . If  $d_G(v) \leq n - 2$  for all  $v \in V(G)$ , then  $n^2 - n - 2q = n(n - 1) - 2q = 2m(G) \leq n(n - 2) = n^2 - 2n$  and thus  $q \geq \lceil \frac{n}{2} \rceil$ .

Let  $l$  be the number of vertices in  $G$  with degree  $n - 2$ . Then  $2m(G) = n^2 - n - 2q \leq l(n - 2) + (n - l)(n - 3) = n^2 - 3n + l$  and so it follows that  $l \geq 2(n - q) \geq 4$ .

We will now prove by induction on  $n$  that there are at least  $q - 1$  induced cycles of length 4 in  $G$ . For  $n \in \{2, 3\}$  the property  $d_G(v) \leq n - 2$  is not satisfied for any  $q \leq n - 2$ . If  $n = 4$ , then the only possibility for having  $\Delta(G) \leq n - 2$  is when  $q = 2$  and  $G \cong C_4$ . Now suppose that  $n \geq 5$ .

*Case 1.* Suppose that there is a vertex  $x$  of degree  $n - 2$  in  $G$  such that the only vertex that is not adjacent to  $x$ , say  $y$ , has degree less than  $n - 2$ . Then all vertices in  $G' := G - x$  have degree at most  $n - 3$  and  $m(\overline{G'}) \leq q - 1$  and so from the induction hypothesis follows that  $G'$  contains at least  $q - 2$  induced cycles of length 4. If all neighbors of  $y$  would be adjacent to each other, that is, if  $G[N_G(y)] \cong K_{d_G(y)+1}$ , then, since  $\Delta(G) \leq n - 2$ , for each  $z \in N_G(y)$  would exist a vertex  $z' \in N_{\overline{G}}(y)$  such that  $zz' \in E(\overline{G})$ . But this would imply that  $q \geq d_G(y) + d_{\overline{G}}(y) = n - 1$ , which is a contradiction. So, there have to be two vertices  $z, w \in N_G(y)$  such that  $zw \in E(\overline{G})$ . It follows that  $xzywx$  is a new induced cycle of length 4 in  $G$  and thus  $G$  has at least  $q - 1$  induced  $C_4$ .

*Case 2.* Suppose that every vertex of degree  $n - 2$  in  $G$  is exactly not adjacent to another vertex of degree  $n - 2$ . Then the vertices of degree  $n - 2$  in  $G$  induce a matching  $M$  in  $\overline{G}$  and thus  $l$  is even and  $|M| = l/2 \geq n - q$ . This implies that if  $xy \in M$  and  $x'y' \in E(\overline{G}) - \{xy\}$ , then the vertices  $x, x', y, y'$  induce a cycle of length 4 in  $G$ . It follows that there are  $|M|(|M| - 1)/2$  induced  $C_4$  with vertices in  $V(M)$  and  $|M|(q - |M|)$  induced  $C_4$  with vertices in both  $V(M)$  and  $V(G) - V(M)$ . Since  $n/2 \geq |M| = l/2 \geq n - q$ , we obtain that there are at least

$$\frac{(n - q - 1)(n - q)}{2} + \frac{(n - q)(2q - n)}{2} = \frac{(n - q)(q - 1)}{2} \geq q - 1$$

cycles of length 4. □

The next two lemmas contain two main structure properties on graphs  $G$  with  $\gamma_k(G) = \gamma(G) + k - 2$ , which we will need in order to prove the main results.

**Lemma 2.21** (Hansberg [34]) *Let  $G$  be a connected graph and  $k$  an integer with  $\Delta(G) \geq k \geq 2$ . If  $\gamma_k(G) = \gamma(G) + k - 2$  and  $D$  is a minimum  $k$ -dominating set of  $G$ , then, for every vertex  $u \in V - D$  and every set  $A_u \subseteq N(u) \cap D$  with  $|A_u| = k$ , there are non-adjacent vertices  $x_u, x'_u \in V - D$  such that  $D \cap N(x_u) = D \cap N(x'_u) = A_u$ .*

**Proof.** Since  $\Delta(G) \geq k \geq 2$ ,  $V - D$  is not empty. Let  $u$  be a vertex in  $V - D$  and  $A_u \subseteq N(u) \cap D$  a set such that  $|A_u| = k$ . Suppose to the contrary that for all vertices in  $x \in V - (D \cup \{u\})$  either  $|A_u \cap N(x)| \leq k - 1$  or  $|D \cap N(x)| \geq k + 1$  and  $A_u \subset N(x)$  holds. Then every vertex in  $V - (D \cup \{u\})$  has at least one neighbor in  $D - A_u$  and every vertex from  $A_u$  is dominated by  $u$ . Hence,  $(D - A_u) \cup \{u\}$  is a dominating set of  $G$  with  $\gamma_k(G) - k + 1$  vertices, which is a contradiction to our hypothesis. Therefore, there is a vertex  $x_u \in V - (D \cup \{u\})$  such that  $N(x_u) \cap D = A_u$ . If  $x_u$  would be the only vertex with this property, then  $(D - A_u) \cup \{x_u\}$  would be a dominating set of  $G$  with  $\gamma_k(G) - k + 1$  vertices. Hence there is another vertex  $y \in V - D$  such that  $N(y) \cap D = A_u$ . If all vertices  $y \in V - (D \cup \{x_u\})$  with  $N(y) \cap D = A_u$  were adjacent to  $x_u$ , then the set  $(D - A_u) \cup \{x_u\}$  would again be a dominating set of  $G$ . Therefore, there has to be a vertex  $x'_u \in V - (D \cup \{x_u\})$  with  $N(x'_u) \cap D = A_u$  such that it is not adjacent to  $x_u$  and we are done.  $\square$

**Lemma 2.22** (Hansberg [34]) *Let  $G$  be a connected graph with  $\gamma_k(G) = \gamma(G) + k - 2$  for an integer  $k$  with  $\Delta(G) \geq k \geq 2$ . If  $D$  is a minimum  $k$ -dominating set of  $G$  and  $u \in D$ , then there is a vertex  $x \in V - D$  such that  $x \in N(u)$  and  $|D \cap N(x)| = k$ .*

**Proof.** Since  $\Delta(G) \geq k \geq 2$ ,  $V - D$  is not empty. Let  $u \in D$ . Assume for contradiction that  $u$  does not have neighbors in  $V - D$ . Suppose first that  $N(u) \cap N(x) \cap D = \emptyset$  for every vertex  $x \in V - D$ . Let  $x \in V - D$  and let  $A_x$  be a subset of  $N(x) \cap D$  with  $|A_x| = k$  and let  $v \in A_x$ . We will show that the set  $D' = (D - (A_x \cup N(u))) \cup \{x, v\}$  is a dominating set of  $G$ . Let  $z \in V - D'$ . If  $z \in A_x - \{v\}$ , then it is dominated by  $x$ . If  $z \in N(u)$ , then it is dominated by  $u$ . If  $z \in V - (D \cup \{x\})$ , then it has at least one neighbor in  $(D - A_x) \cup \{v\}$  and it does not belong to  $N(u)$ . Hence,  $D'$  is a dominating

set of  $G$  and thus

$$\begin{aligned}\gamma(G) &\leq |D'| = |(D - (A_x \cup N(u))) \cup \{x, v\}| \\ &= \gamma_k(G) - k - |N(u)| + 2 \\ &\leq \gamma_k(G) - k + 1,\end{aligned}$$

for  $G$  is connected, and we obtain a contradiction. It follows that there is a vertex  $x \in V - D$  which has at least one common neighbor with  $u$  in  $D$ . Let now  $A_x$  be a subset of  $N(x) \cap D$  with  $|A_x| = k$ , such that  $N(u) \cap A_x \neq \emptyset$ . Now it is easy to check that  $(D - (A_x \cup \{u\})) \cup \{x, y\}$  is a dominating set of  $G$ , where  $y \in N(u) \cap A_x$ , and we obtain again the contradiction that  $\gamma(G) \leq \gamma_k(G) - k + 1$ . Thence,  $u$  has at least one neighbor in  $V - D$ .

Suppose now for contradiction that every vertex in  $N(u) \cap (V - D)$  has at least  $k + 1$  neighbors in  $D$ . Let  $x \in N(u) \cap (V - D)$  and let  $A_x$  be a subset of  $D \cap N(x)$  with  $|A_x| = k$  such that  $u \notin A_x$ . Define  $D'' = (D - (A_x \cup \{u\})) \cup \{x, v\}$ , where  $v$  is a vertex in  $A_x$ . Let  $z \in V - D''$ . If  $z \in A_x \cup \{u\}$ , then it is dominated by  $x$ . If  $z \in V - (D \cup N(u))$ , then it has  $k$  neighbors in  $D - \{u\}$  and thus at least one neighbor in  $(D - (A_x \cup \{u\})) \cup \{v\}$ . If  $z \in (V - D) \cap N(u)$ , then it has at least  $k + 1$  neighbors in  $D$  and hence at least one neighbor in  $(D - (A_x \cup \{u\})) \cup \{v\}$ . It follows that  $D''$  is a dominating set of  $G$  with  $\gamma_k(G) - k + 1$  vertices, a contradiction to our hypothesis. Therefore, there is a vertex in  $(V - D) \cap N(u)$  that has exactly  $k$  neighbors in  $D$ .  $\square$

**Theorem 2.23** (Hansberg [34]) *Let  $G$  be a connected graph and  $k$  an integer with  $\Delta(G) \geq k \geq 2$ . If  $\gamma_k(G) = \gamma(G) + k - 2$ , then every vertex of  $G$  lies on an induced cycle of length 4.*

**Proof.** Let  $D$  be a minimum  $k$ -dominating set of  $G$  and let  $x$  be a vertex of  $G$ .

*Case 1.* Suppose that  $x \in V - D$ . Let  $A_x$  be a subset of  $N(x) \cap D$  with  $|A_x| = k$ . Let  $X$  be the set of vertices in  $V - (D \cup \{x\})$  that contain the set  $A_x$  in its neighborhood. By Lemma 2.21, the set  $X$  is not empty. Suppose that  $x$  is adjacent to every vertex from  $X$ . Define  $D' = (D - A_x) \cup \{x\}$  and let  $z \in V - D'$ . If  $z \in A_x \cup X$ , it is dominated by  $x$ . If  $z \in V - (D \cup X \cup \{x\})$ , it has a neighbor in  $D - A_x$ . Hence,  $D'$  is a dominating set of  $G$  with  $\gamma_k(G) - k + 1$  vertices, a contradiction to the hypothesis that  $\gamma_k(G) = \gamma(G) + k - 2$ . It follows that there is a vertex  $y \in X$  that is not adjacent to  $x$ . Since, by Theorem 2.18,  $\Delta(G[A_x]) \leq k - 2$  holds, there are two non-adjacent vertices  $a, b \in A_x$ . It is now evident that the vertices  $x, y, a$  and  $b$  induce a cycle of length four in  $G$ .

*Case 2.* Suppose that  $x \in D$ . By Lemma 2.22, there is a vertex  $u$  such that  $x \in N(u) - D$ . Let  $A_u$  be a subset of  $N(u) \cap D$  such that  $x \in A_u$  and  $|A_u| = k$ . Now Lemma 2.21 implies that there are non-adjacent vertices  $x_u, x'_u \in V - D$  with  $D \cap N(x_u) = D \cap N(x'_u) = A_u$ . Since from Theorem 2.18 we have that  $\Delta(G[A_u]) \leq k - 2$ ,  $A_u$  contains at least a vertex  $v$  which is not adjacent to  $x$ . Hence, the vertices  $x, v, x_u$  and  $x'_u$  induce a cycle of length 4 containing  $x$ .  $\square$

**Corollary 2.24** (Hansberg [34]) *Let  $G$  be a connected graph. If there is a vertex  $u \in V$  that is not contained in any induced cycle of length 4 of  $G$ , then  $\gamma_k(G) \geq \gamma(G) + k - 1$ .*

As Theorem 2.23 suggests, graphs  $G$  with  $\gamma_k(G) = \gamma(G) + k - 2$ , contain many induced cycles of length 4. Next, we will determine a lower bound for the number of induced cycles of length 4 contained in such graphs. Before that, we need the following lemma.

**Lemma 2.25** (Hansberg [34]) *Let  $G$  be a graph with vertex set  $V = V_1 \cup V_2$  such that  $|V_1| = |V_2| = k \geq 2$  and  $V_1 \neq V_2$ . If  $m(G[V_i]) \leq k - 2$  for  $i = 1, 2$  and  $\delta(G) \geq n(G) - k + 1$ , then  $|V_1 \cap V_2| \leq 1$ .*

**Proof.** Let  $r$  be the number of edges contained in  $G[V_1 \cap V_2]$  and let  $r = |V_1 \cap V_2|$ . Suppose that  $r \geq 2$ . With the condition that  $\delta(G) \geq n(G) - k + 1 = k - r + 1$ , we obtain

$$m(V_1 \cap V_2, V - (V_1 \cap V_2)) \geq r(k - r + 1) - 2r.$$

Without loss of generality, we can suppose that

$$m(V_1 \cap V_2, V_1 - V_2) \geq \frac{r(k - r + 1) - 2r}{2}.$$

Hence,  $k - 2 \geq m(G[V_1]) \geq m(V_1 \cap V_2, V_1 - V_2) + r \geq \frac{1}{2}r(k - r + 1)$  and thus  $r^2 - r - 4 \geq k(r - 2)$ . Since  $k \geq r + 1$  and  $r \geq 2$ , it follows that

$$r^2 - r - 4 \geq k(r - 2) \geq (r + 1)(r - 2) = r^2 - r - 2,$$

which is a contradiction. Therefore,  $r = |V_1 \cap V_2|$  is at most 1.  $\square$

**Theorem 2.26** (Hansberg [34]) *Let  $G$  be a connected graph and  $k$  an integer with  $\Delta(G) \geq k \geq 2$ . If  $\gamma_k(G) = \gamma(G) + k - 2$ , then  $G$  contains at least  $(\gamma(G) - 1)(k - 1)$  induced cycles of length 4.*

**Proof.** Let  $D$  be a minimum  $k$ -dominating set of  $G$ . Then Lemma 2.21 implies that  $|V - D| \geq 2$ .

*Claim 1.* Let  $u \in V - D$  and  $x_u$  and  $x'_u$  be like in Lemma 2.21. Then  $G[A_u \cup \{x_u, x'_u\}]$  contains at least  $k - 1$  induced cycles  $C_4$ . Moreover, if  $m(G[A_u]) \geq k - 1$ ,  $G[A_u \cup \{x_u, x'_u\}]$  has at least  $k - 1$  induced cycles of length 4 each containing both vertices  $x_u$  and  $x'_u$ .

*Proof.* Since  $x_u$  and  $x'_u$  are not adjacent in  $G$  and  $A_u = N(x_u) \cap D = N(x'_u) \cap D$ , every two non adjacent vertices from  $A_u$  together with  $x_u$  and  $x'_u$  induce a cycle of length 4 in  $G[A_u \cup \{x_u, x'_u\}]$ . Hence, if  $m(G[A_u]) \geq k - 1$ , there are at least  $k - 1$  induced cycles  $C_4$  in  $G[A_u \cup \{x_u, x'_u\}]$ , all of them containing both vertices  $x_u$  and  $x'_u$ . Now suppose that  $m(G[A_u]) \leq k - 2$ . As  $\Delta(G[A_u]) \leq k - 2$ , we obtain from Lemma 2.20 that  $m(G[A_u]) \geq \lceil \frac{k}{2} \rceil$  and that there are at least  $m(G[A_u]) - 1$  induced cycles  $C_4$  in  $G[A_u]$ . Hence, in  $G[A_u \cup \{x_u, x'_u\}]$  there are at least  $2m(G[A_u]) - 1 \geq 2\lceil \frac{k}{2} \rceil - 1 \geq k - 1$  induced cycles  $C_4$ .  $\parallel$

Now let  $B' \neq \emptyset$  be a proper subset of  $V - D$ . For each  $u \in B'$ , let  $A_u$  be a subset of  $N(u) \cap D$  such that  $|A_u| = k$ . Define  $S = \bigcup_{u \in B'} A_u$  and  $B = \{v \in V - D \mid |N(v) \cap S| \geq k\}$ .

*Claim 2.* Let  $S \neq D$ . Then there is a vertex  $y \in V - (D \cup B)$  such that  $k - 2 \leq |N(y) \cap S| \leq k - 1$ .

*Proof.* Since  $S \neq D$ , it follows from Lemma 2.22 that the set  $V - (D \cup B)$  is not empty. From the definition of the set  $B$ , the inequality  $|N(y) \cap S| \leq k - 1$  follows immediately for all  $y \in V - (D \cup B)$ . Now we will prove that there is a vertex  $y \in V - (D \cup B)$  such that  $|N(y) \cap S| \geq k - 2$ . For the case that  $k = 2$ , it is trivial. For the case that  $k \geq 3$ , suppose to the contrary that  $|N(y) \cap S| \leq k - 3$  for every vertex  $y \in V - (D \cup B)$ . Let  $u \in B'$ ,  $x \in A_u$  and let  $v, w \in (N(y) \cap D) - S$  for a vertex  $y \in V - (D \cup B)$ . We will prove that  $D' = (D - (A_u \cup \{v, w\})) \cup \{x, y, u\}$  is a dominating set of  $G$ . Let  $z \in V - D'$ . If  $z \in A_u - \{x\}$ , then it is dominated by  $u$ . If  $z \in \{v, w\}$ , then it is dominated by  $y$ . Since every vertex in  $B - \{u\}$  has  $k$  neighbors in  $S$ , each  $z \in B - \{u\}$ , it has at least one neighbor in  $(S - A_u) \cup \{x\}$ . If  $z \in V - (D \cup B \cup \{y\})$ , then it has at least 3 neighbors in  $D - S$  and thus at least one neighbor in  $D - (S \cup \{v, w\})$ . Hence,  $D'$  is a dominating set of  $G$  and, consequently,

$$\begin{aligned} \gamma(G) &\leq |D'| = |(D - (A_u \cup \{v, w\})) \cup \{x, y, u\}| \\ &= \gamma_k(G) - k - 2 + 3 = \gamma_k(G) - k + 1. \end{aligned}$$

This contradiction proves Claim 2.  $\parallel$

*Claim 3.* Let  $k \geq 3$  and suppose that  $S \neq D$  and that  $|N(z) \cap S| \leq k - 2$  for all vertices  $z \in V - (D \cup B)$ . For a vertex  $y \in V - (D \cup B)$  with  $|N(y) \cap S| = k - 2$ , let  $A_y \subseteq N(y) \cap D$  with  $|A_y| = k$  and  $N(y) \cap S \subset A_y$ . Then there is a vertex  $y' \in V - (D \cup B \cup \{y\})$  and a set  $A_{y'} \subseteq N(y') \cap (S \cup A_y)$  such that  $|A_{y'}| = k$  and  $A_{y'} \neq A_y$ .

*Proof.* From Lemma 2.21, since  $S \neq D$ ,  $V - (D \cup B)$  has at least 2 vertices. By Claim 2 and since  $|N(z) \cap S| \leq k - 2$  for all  $z \in V - (D \cup B)$ , the existence of the vertex  $y \in V - (D \cup B)$  with  $|N(y) \cap S| = k - 2$  is guaranteed. Suppose that for all  $z \in V - (D \cup B \cup \{y\})$  either  $|N(z) \cap (S \cup A_y)| \leq k - 1$  or  $N(z) \cap D = A_y$ . Let  $\{v, w\} = A_y - S$  and  $u \in A_y \cap S$ . From the construction of  $S$  follows that there is a vertex  $x \in B'$  such that  $u \in A_x$ . Now we will show that  $D' = (D - (A_x \cup \{v, w\})) \cup \{u, x, y\}$  is a dominating set of  $G$ . Let  $z$  be a vertex from  $V - D'$ . If  $z \in \{v, w\}$ , it is dominated by  $y$ . If  $z \in A_x - \{u\}$ , then  $z$  is dominated by  $x$ . If  $z \in B - \{x\}$ , then  $z$  has  $k$  neighbors in  $S$  and thus at least one neighbor in  $(S - A_x) \cup \{u\} \subset D'$ . Let now  $z$  be in  $V - (B \cup D \cup \{y\})$ . If  $|N(z) \cap (S \cup A_y)| \leq k - 1$ , then  $z$  has at least a neighbor in  $D - (S \cup A_y) \subset D'$ . If  $A_y = N(z) \cap D$ , then  $z$  is dominated by  $u$ . Hence, we obtain the contradiction that  $D'$  is a dominating set of  $G$  with  $\gamma_k(G) - k + 1$  vertices and Claim 3 is proved.  $\parallel$

*Claim 4.* Let  $k = 2$  and suppose that  $S \neq D$  and that  $N(z) \cap S = \emptyset$  for all vertices  $z \in V - (D \cup B)$ . Then there is a vertex  $y \in V - (D \cup B)$  with a neighbor in  $B$ . Moreover, if  $A_y \subseteq D \cap N(y)$  is a set with  $|A_y| = 2$  and  $Z \subseteq V - (D \cup B)$  is the set of all vertices  $z$  with  $A_y \subseteq N(z)$ , then  $m(G[Z]) \geq 2$ .

*Proof.* Because of  $S \neq D$ ,  $V - (D \cup B) \neq \emptyset$ . Since  $G$  is connected, and, from Corollary 2.19,  $D$  is independent, there has to be a vertex  $y \in V - (S \cup B)$  with a neighbor  $x$  in  $B$ . Let  $A_x \subseteq N(x) \cap S$  with  $|A_x| = 2$  and let  $u \in A_x$ . The assumption that  $y \in D - S$ , would imply that  $(D - \{u, y\}) \cup \{x\}$  is a dominating set of  $G$  with less vertices than  $D$ . Hence  $y \in V - (D \cup B)$ . From Lemma 2.21,  $|Z| \geq 2$ . If  $|Z| = 2$ , say  $Z = \{y, y'\}$ , then  $(D - (A_y \cup \{u\})) \cup \{x, y'\}$  would be a dominating set of  $G$  with one vertex less than  $D$ . Thus,  $|Z| \geq 3$ . Suppose that  $m(G[Z]) \leq 1$ . Then there is a vertex  $z \in Z$  adjacent to all vertices of  $Z - \{z\}$  and it follows that  $(D - A_y) \cup \{z\}$  is a dominating set of  $G$  with less vertices than  $D$ , a contradiction. Hence,  $m(G[Z]) \geq 2$ .  $\parallel$

Now let  $y_0$  be an arbitrary vertex in  $V - D$ . Let  $A_0 \subseteq N(y_0) \cap D$  such that  $|A_0| = k$ . Then we set  $S_0 = A_0$  and  $B_0 = \{v \in V - D \mid |N(v) \cap S_0| \geq k\}$ . For  $i \geq 1$ , unless  $S_{i-1} = D$ , let  $y_i$  be a vertex in  $V - (D \cup B_{i-1})$  such that

$|N(y_i) \cap S_{i-1}| = k - 1$  or, in case that there is no such vertex, such that  $|N(y_i) \cap S_{i-1}| = k - 2$  (existence was shown in Claim 2). If, additionally to the latter,  $k = 2$ , choose a vertex  $y_i$  such that it has a neighbor in  $B_{i-1}$  (see Claim 4). Further, let  $A_i$  be a subset of  $N(y_i) \cap D$  with  $|A_i| = k$  and  $N(y_i) \cap S_{i-1} \subset A_i$  and define recursively

$$S_i = S_{i-1} \cup A_i \text{ and}$$

$$B_i = \{v \in V - D \mid |N(v) \cap S_i| \geq k\}.$$

Since for all indices  $i$  for which  $S_{i-1} \neq D$ , evidently  $|S_{i-1}| < |S_i|$  holds, there has to be an integer  $l \geq 1$  such that  $S_l = D$ . For  $0 \leq i \leq l$ , we define  $G_i = G[S_i \cup B_i]$ . Note that, if  $m(G[A_{i_1}]) \leq k - 2$  and  $m(G[A_{i_2}]) \leq k - 2$  for two indices  $0 \leq i_1, i_2 \leq l$ , then, since  $\Delta(G[A_{i_1} \cup A_{i_2}]) \leq k - 2$ , the conditions for Lemma 2.25 with respect to the graph  $G[A_{i_1} \cup A_{i_2}]$  are fulfilled and hence  $|A_{i_1} \cap A_{i_2}| \leq 1$ . For each  $y_i$ , let  $x_i$  and  $x'_i$  be the non-adjacent vertices  $x_{y_i}$  and, respectively,  $x'_{y_i}$  of Lemma 2.21.

*Claim 5.* In  $G_i$  there are at least  $(|S_i| - k + 1)(k - 1)$  induced cycles  $C_4$  for all  $0 \leq i \leq l$ .

*Proof.* If  $i = 0$ , since  $G[A_0 \cup \{x_0, x'_0\}]$  is a subgraph of  $G_0$ , the statement follows directly from Claim 1. Moreover, if  $m(G[A_0]) \geq k - 1$ , there are at least  $k - 1$  induced cycles  $C_4$  in  $G_0$  containing the vertices  $x_0$  and  $x'_0$ . If  $l = 0$ , we are ready. Suppose now that  $l \geq 1$  and that, for an index  $0 \leq i \leq l - 1$ , the statement holds. Moreover, assume that every cycle counted until now is contained in a graph  $G[A_j \cup \{x_j, x'_j\}]$  for some  $1 \leq j \leq l - 1$  and in such manner that, if  $m(G[A_j]) \geq k - 1$ , the cycle contains both vertices  $x_j$  and  $x'_j$ .

From Claim 1, we know that  $G[A_{i+1} \cup \{x_{i+1}, x'_{i+1}\}]$  contains at least  $k - 1$  induced cycles  $C_4$ . If  $m(G[A_{i+1}]) \geq k - 1$ , there are at least  $k - 1$  such induced cycles  $C_4$  containing the vertices  $x_{i+1}$  and  $x'_{i+1}$  and thus all different from the cycles of  $G_i$ . If  $m(G[A_{i+1}]) \leq k - 2$ , we already noted that  $|A_j \cap A_{i+1}| \leq 1$  for all indices  $j$  such that  $m(G[A_j]) \leq k - 2$ , and hence the cycles counted here are new, too. If  $|N(y_{i+1}) \cap S_i| = k - 1$ , then  $|S_{i+1}| = |S_i| + 1$  and, by the induction hypothesis, there are at least  $(|S_i| - k + 1)(k - 1)$  induced cycles  $C_4$  in  $G_i$  and thus at least  $(|S_i| - k + 1)(k - 1) + (k - 1) = (|S_{i+1}| - k + 1)(k - 1)$  in  $G_{i+1}$ .

Now suppose that  $|N(y_{i+1}) \cap S_i| = k - 2$ . Then we have  $|S_{i+1}| = |S_i| + 2$ . Hence, in this case we need to find  $k - 1$  more cycles. We distinguish two cases.

Case 1:  $k \geq 3$ . By Claim 3, there is a vertex  $z \in V - (D \cup B_i)$  different from  $y_{i+1}$  and a set  $A_z \subseteq N(z) \cap (S \cup A_{i+1})$  such that  $|A_z| = k$  and  $A_z \neq A_{i+1}$ . Thus the vertices  $x_z$  and  $x'_z$  are both different from  $x_{i+1}$  and  $x'_{i+1}$ . If  $m(G[A_z]) \geq$

$k - 1$ , Claim 1 implies that there are at least  $k - 1$  induced cycles  $C_4$  in  $G[A_z \cup \{x_z, x'_z\}]$  containing both vertices  $x_z$  and  $x'_z$  and thus different from all other induced cycles counted until yet. If  $m(G[A_z]) \leq k - 2$ , we obtain, by Claim 1, that there are at least  $k - 1$  induced cycles  $C_4$  in  $G[A_z \cup \{x_z, x'_z\}]$ . Since  $|A_z \cap A_j| \leq 1$  for all indices  $0 \leq j \leq i + 1$  such that  $m(G[A_j]) \leq k - 2$ , all these cycles are new, too. Hence, we can count with  $k - 1$  more induced cycles  $C_4$ .

Case 2:  $k = 2$ . Then we can apply Claim 4 by setting  $y_{i+1}$  for  $y$ . Since  $m(G[Z]) \geq 2$ , there has to be a vertex  $z \in Z - \{x_{i+1}, x'_{i+1}\}$  being not adjacent to some  $z' \in Z$  (this includes the cases  $z' = x_{i+1}$  and  $z' = x'_{i+1}$ ). So,  $z$  and  $z'$  together with the vertices from  $A_{i+1}$  build another induced  $C_4$  with which we can count.

Hence, by the induction hypothesis, there are at least

$$(|S_i| - k + 1)(k - 1) + 2(k - 1) = (|S_{i+1}| - k + 1)(k - 1)$$

induced cycles of length 4 in  $G_{i+1}$ .  $\parallel$

By the last claim, setting  $i = l$ , we obtain that  $G = G_l$  has at least

$$\begin{aligned} (|S_l| - k + 1)(k - 1) &= (|D| - k + 1)(k - 1) \\ &= (\gamma_k(G) - k + 1)(k - 1) \\ &= (\gamma(G) - 1)(k - 1) \end{aligned}$$

induced cycles of length 4.  $\square$

**Example 2.27** (Hansberg [34]) *Let  $l$  and  $k$  be two positive integers, where  $k \geq 2$ . Let  $G$  be a graph consisting of a complete graph  $H$  on  $k - 1$  vertices and of vertices  $u_i, v_i, w_i$ , for  $1 \leq i \leq l$ , such that every  $u_i$  and  $w_i$  is adjacent to every vertex of  $H$  and to  $v_i$  (see Figure 1). Then it is easy to see that  $\gamma_k(G) = k + l - 1$ ,  $\gamma(G) = l + 1$  and thus  $\gamma_k(G) = \gamma(G) + k - 2$ . Since  $G$  contains exactly  $l(k - 1) = (\gamma(G) - 1)(k - 1)$  induced cycles of length 4, it follows that the bound in Theorem 2.26 is sharp.*

Using Theorem 1.3, we obtain easily following corollary.

**Corollary 2.28** (Hansberg [34]) *Let  $G$  be a graph and  $k$  an integer such that  $2 \leq k \leq \Delta(G)$ . If  $\gamma_k(G) = \gamma(G) + k - 2$ , then  $G$  contains at least  $(\frac{n}{\Delta(G)+1} - 1)(k - 1)$  induced cycles of length 4.*

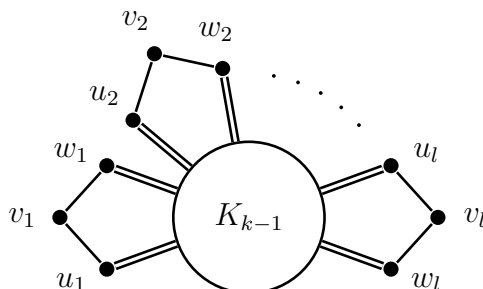

Figure 2.1: Example of a graph  $G$  with  $\gamma_k(G) = \gamma(G) + k - 2$  and exactly  $(\gamma(G) - 1)(k - 1)$  induced cycles of length 4. A double line connecting a vertex  $u_i$  or  $w_i$  to the complete graph  $K_{k-1}$  in the middle means that it is adjacent to all vertices of  $K_{k-1}$ .

Note that, if  $G$  is a graph with  $\gamma_k(G) = \gamma(G) + k - 2$  for an integer  $k$  with  $2 \leq k \leq \Delta(G)$ ,  $\gamma(G)$  is at least 2 and thus  $\Delta(G) \leq n(G) - 2$ , which implies that the factor  $(\frac{n}{\Delta(G)+1} - 1)$  above is always positive.

Reverting the assertion of the theorem, we gain an improvement of Fink and Jacobson's lower bound and we obtain, as a corollary, a theorem of Chellali, Favaron, Hansberg and Volkmann.

**Corollary 2.29** (Hansberg [34]) *Let  $G$  be a graph with  $\Delta(G) \leq n(G) - 2$ . If  $G$  has less than  $(\gamma(G) - 1)(k - 1)$  induced cycles of length 4 for an integer  $k$  with  $\Delta(G) \geq k \geq 2$ , then  $\gamma_k(G) \geq \gamma(G) + k - 1$ .*

**Corollary 2.30** (Chellali, Favaron, Hansberg, Volkmann [16]) *If  $G$  is a graph with at most  $k - 2$  induced cycles of length 4 for an integer  $k$  with  $\Delta(G) \geq k \geq 2$ , then  $\gamma_k(G) \geq \gamma(G) + k - 1$ .*

**Corollary 2.31** (Chellali, Favaron, Hansberg, Volkmann [16]) *If  $G$  is a graph without an induced cycle  $C_4$ , then  $\gamma_k(G) \geq \gamma(G) + k - 1$  for every positive integer  $k$  with  $\Delta(G) \geq k \geq 2$ .*

**Proof.** If  $\Delta(G) = n(G) - 1$ , then  $\gamma(G) = 1$  and, since  $\Delta(G) \geq k \geq 2$ , evidently  $\gamma_k(G) \geq k$ . If  $\Delta(G) \leq n(G) - 2$ , previous corollary yields the desired assertion.  $\square$

Since triangulated graphs do not contain induced  $C_4$ , we also obtain the following corollary.

**Corollary 2.32** (Chellali, Favaron, Hansberg, Volkmann [16]) *If  $G$  is a triangulated graph, then  $\gamma_k(G) \geq \gamma(G) + k - 1$  for every positive integer  $k$  with  $\Delta(G) \geq k \geq 2$ .*

In particular, every nontrivial block graph  $G$  has the property  $\gamma_k(G) \geq \gamma(G) + k - 1$  for every positive integer  $k$  with  $\Delta(G) \geq k \geq 2$ . If we regard the graph  $G = K_n \circ K_1$ , where  $n$  is an integer with  $n \geq k$ , it is evident that  $G$  fulfills  $\gamma_k(G) = n + k - 1$  and  $\gamma(G) = n$ . This shows that Corollary 2.32 is best possible.

In 1996, Reed gave the following upper bound for the usual domination number  $\gamma$ .

**Theorem 2.33** (Reed [62], 1996) *If  $G$  is a connected graph with minimum degree  $\delta \geq 3$ , then  $\gamma(G) \leq \frac{3}{8}n(G)$ .*

Theorems 2.33 and 1.3 lead directly to the next observation.

**Observation 2.34** (Chellali, Favaron, Hansberg, Volkmann [16]) *If  $G$  is a graph of order  $n$ , maximum degree  $\Delta$  and  $\delta(G) \geq 3$ , then*

$$\gamma_k(G) - \gamma(G) \geq \frac{5k - 3\Delta}{8(\Delta + k)} n$$

for every integer  $k \in \mathbb{N}$ .

**Remark 2.35** (Chellali, Favaron, Hansberg, Volkmann [16]) *If  $G$  is a graph of order  $n$  with  $\delta(G) \geq 3$  and  $5k > 3\Delta(G)$ , then previous observation yields  $\gamma_k(G) \geq \gamma(G) + \frac{5k-3\Delta}{8(\Delta+k)} n$ . This shows that if  $c \geq k - 2$  is an arbitrary constant, then there exist only a finite number of graphs  $G$  such that  $\delta(G) \geq 3$ ,  $5k > 3\Delta(G)$  and  $\gamma_k(G) \leq \gamma(G) + c$ .*

**Remark 2.36** (Chellali, Favaron, Hansberg, Volkmann [16]) *Let  $G$  be a cubic graph. Observation 2.34 implies that  $\gamma_2(G) \geq \frac{n}{40} + \gamma(G)$  and  $\gamma_3(G) \geq \frac{n}{8} + \gamma(G)$ . Hence the cubic graphs with  $\gamma_2(G) = \gamma(G) + 1$  have at most 40 vertices and those with  $\gamma_3(G) = \gamma(G) + 1$  at most 8. Analyzing all cubic graphs with at most 8 vertices, it is a simple matter to verify that the only cubic graph that fulfills  $\gamma_3(G) = \gamma(G) + 1$  is  $G \cong K_{3,3}$ .*

**Remark 2.37** *Analogously to previous remark, it is easy to see that there are no cubic graphs  $G$  with  $\gamma(G) = \gamma_2(G)$  and thus always  $\gamma_2(G) \geq \gamma(G) + 1$  holds for a cubic graph  $G$ .*

**Remark 2.38** *More generally, suppose that we know that for any graph  $G$  on  $n$  vertices, there is a factor  $f(G) \in (0,1)$  such that  $\gamma(G) \leq f(G)n$ , where  $f(G)$  can depend on different parameters of  $G$  (like for example the minimum degree). Then the number of graphs  $G$  with  $\gamma_k(G) = \gamma(G) + k - 2$  and  $\frac{k}{k+\Delta(G)} > f(G)$  is finite.*

Theorem 2.17 implies that  $\gamma_k(G) > \gamma(G)$  for  $k \geq 3$ . However, for  $k = 2$  the equality  $\gamma_2(G) = \gamma(G)$  is possible. Next, we will present some sufficient as well as some necessary conditions for graphs  $G$  with the property that  $\gamma_2(G) = \gamma(G)$ .

A subset  $S \subseteq V(G)$  is called a *covering* if every edge in  $G$  is incident to at least one vertex of  $S$ . The cardinality of a minimum covering of  $G$  is denoted with  $\beta(G)$  and is called the *covering number* of  $G$ .

**Proposition 2.39** (Teschner, Volkmann (cf. [68], p. 221)) *If  $G$  is a connected graph with  $\gamma(G) = \beta(G)$ , then  $\delta(G) \leq 2$ .*

**Observation 2.40** (Hansberg [34]) *If  $G$  is a graph with  $\delta(G) \geq k \geq 2$  for an integer  $k$ , then every covering is also a  $k$ -dominating set and thus  $\gamma_k(G) \leq \beta(G)$ .*

**Observation 2.41** (Hansberg [34]) *If  $G$  is a graph with  $\delta(G) \geq k \geq 2$  for an integer  $k$  and such that  $\beta(G) \leq \gamma(G) + k - 2$ , then  $\gamma_k(G) = \gamma(G) + k - 2$ .*

**Proof.** With Theorem 2.17 and previous observation, we obtain

$$\gamma(G) + k - 2 \leq \gamma_k(G) \leq \beta(G) \leq \gamma(G) + k - 2,$$

and thus the statement follows.  $\square$

We obtain directly, for the case that  $k = 2$ , the following corollaries.

**Corollary 2.42** (Blidia, Chellali, Volkmann [7], 2006) *If  $G$  is a graph with  $\delta(G) \geq 2$ , then every covering is also a 2-dominating set and thus  $\gamma_2(G) \leq \beta(G)$ .*

**Corollary 2.43** (Hansberg, Volkmann [39], 2007) *If  $G$  is a graph with  $\delta(G) \geq 2$  and  $\gamma(G) = \beta(G)$ , then  $\gamma_2(G) = \gamma(G)$ .*

**Theorem 2.44** (Hansberg, Volkmann [39], 2007) *If  $G$  is a connected non-trivial graph with  $\gamma_2(G) = \gamma(G)$ , then  $\delta(G) \geq 2$ .*

**Proof.** Assume that  $\delta(G) = 1$  and let  $u$  be a leaf of  $G$ . If  $D$  is a  $\gamma_2(G)$ -set and  $S = V(G) - D$ , then  $u \in D$ . If  $S = \emptyset$ , then we arrive at the contradiction  $\gamma(G) < n(G) = \gamma_2(G)$ . So we assume now that  $S \neq \emptyset$ . Let  $w$  be the neighbor of the leaf  $u$ . If  $w \in D$ , then  $D' = D - \{u\}$  is a dominating set of  $G$  with  $|D'| = |D| - 1$ , a contradiction to  $|D| = \gamma_2(G) = \gamma(G)$ . If  $w \in S$ , then there exists a vertex  $v \in N(w) \cap D$  with  $v \neq u$ . Since each vertex in  $S$  is adjacent to 2 or more vertices in  $D$ , we observe that  $D'' = (D \cup \{w\}) - \{u, v\}$  is a dominating set of  $D$  with  $|D''| = |D| - 1$ . This is a contradiction to  $|D| = \gamma(G)$ , and the proof is complete.  $\square$

**Theorem 2.45** (Hansberg, Volkmann [39], 2007) *Let  $G$  be a connected non-trivial graph with  $\gamma_2(G) = \gamma(G)$ . Then  $G$  contains a bipartite factor  $H$  with  $\gamma(H) = \beta(H)$  and  $\delta(H) = 2$ .*

**Proof.** Let  $D$  be a  $\gamma_2(G)$ -set and  $S = V(G) - D$ . In view of Theorem 2.44,  $\delta(G) \geq 2$  and thus  $S \neq \emptyset$ . By Corollary 2.19,  $D$  is independent.

If we delete all edges in  $G[S]$ , then we obtain a bipartite factor  $H$  of  $G$  such that each vertex in  $S$  is furthermore adjacent to 2 or more vertices in  $D$ . Thus  $\delta(H) \geq 2$ ,  $\gamma_2(H) = \gamma_2(G) = \gamma(G)$  and  $D$  is a covering of  $H$ . This implies

$$\gamma(G) = \gamma(H) \leq \beta(H) \leq \gamma_2(G) = \gamma(G)$$

and consequently  $\gamma(H) = \beta(H)$ . From Proposition 2.39 we finally obtain  $\delta(H) = 2$ .  $\square$

Regarding Theorem 2.45, one is tempted to believe that the converse of Corollary 2.43 is valid for all bipartite graphs. However, this assumption is completely wrong. We will illustrate this by the an example, in which  $\gamma_2 = \gamma$  and  $\delta \geq 2$  but  $\beta$  is arbitrary large. The graph in Figure 2.2 consists of two complete bipartite graphs  $K_{2,k}$ , where  $k \geq 4$ . Both are connected by a matching that is built by exactly  $k - 2$  vertices of the two partition sets of order  $k$  of the  $K_{2,k}$ 's. Between the vertices that are incident to this matching one can also add arbitrary many edges such that the graph remains bipartite and the result is the same. It is now evident that  $\gamma_2(G) = \gamma(G) = 4$ ,  $\delta(G) \geq 2$  and  $\beta(G) = k + 2$ .

Anyhow, for cactus graphs without bridges the converse of Corollary 2.43 is valid. We will show this statement by proving the next theorem.

**Theorem 2.46** (Hansberg, Volkmann [39], 2007) *Let  $G$  be a connected cactus graph without bridges. Then  $\gamma_2(G) = \beta(G)$ .*

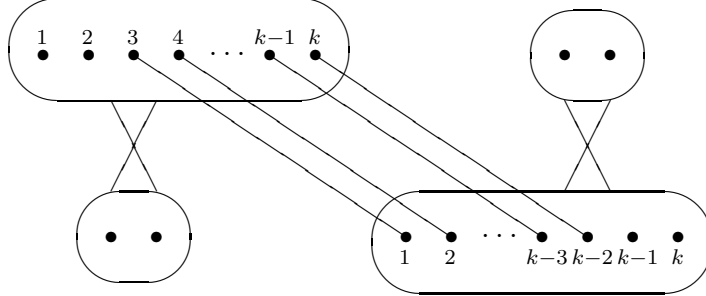

Figure 2.2: Graph with  $\gamma_2(G) = \gamma(G) = 4$ ,  $\delta(G) \geq 2$  and  $\beta(G) = k + 2$ .

**Proof.** We will prove our statement by induction on the number  $\nu(G)$  of cycles in  $G$ . If  $G$  is a cycle, then the statement is clear and every minimum covering of  $G$  is at the same time a  $\gamma_2(G)$ -set. Now assume that  $\nu(G) \geq 2$  and that in every connected cactus graph  $G'$  with  $\nu(G') < \nu(G)$  and without bridges the property  $\gamma_2(G') = \beta(G')$  is fulfilled and that every 2-domination set of  $G'$  is at the same time a covering set. Note that, since there are no bridges,  $\delta(G') \geq 2$  and hence by Corollary 2.42 every covering is also a 2-dominating set. Let  $C$  be an end cycle in  $G$  and  $u$  its cut vertex in  $G$ . Since  $G$  does not contain bridges,  $G' = G - (V(C) - \{u\})$  is again a cactus graph with  $\nu(G') = \nu(G) - 1$  and of course without bridges. It follows by the induction hypothesis  $\gamma_2(G') = \beta(G')$ . Let  $B$  be a minimum covering of  $C$ . Then  $B$  is also a  $\gamma_2(C)$ -set and, without loss of generality, we can assume that  $u \in B$ .

*Case 1.* Assume that there is a  $\gamma_2(G')$ -set  $D'$  of  $G'$  with  $u \in D'$ . By the induction hypothesis we obtain that  $D'$  is also a minimum covering of  $G'$ . The set  $D' \cup (B - \{u\})$  is thus both a covering and a 2-dominating set of  $G$ . Suppose there is a 2-dominating set  $D$  of  $G$  with  $\gamma_2(G) = |D| < |D' \cup (B - \{u\})|$ . We can assume, without loss of generality, that  $u \in D$  and thus  $|D \cap V(C)| = |B|$  and  $D \cap V(G')$  is a 2-dominating set of  $G'$ . It follows

$$|D \cap V(G')| = |D| - |D \cap V(C)| + 1 < |D' \cup (B - \{u\})| - |B| + 1 = |D'|$$

and we obtain a contradiction to the minimality of  $D'$ . Hence  $D' \cup (B - \{u\})$  is a  $\gamma_2(G)$ -set. For being  $\delta(G) \geq 2$  we have again  $\gamma_2(G) \leq \beta(G)$  and since  $D' \cup (B - \{u\})$  is also a covering of  $G$ , we obtain  $|D' \cup (B - \{u\})| = \gamma_2(G) = \beta(G)$ .

*Case 2.* Assume that  $u \notin D'$  for every  $\gamma_2(G')$ -set  $D'$ . By induction hypothesis  $D'$  is also a minimum covering, which implies that  $D' \cup B$  is as well a covering of  $G$  as a 2-dominating set of  $G$ . Suppose there is a 2-dominating

set  $D$  of  $G$  with  $\gamma_2(G) = |D| < |B \cup D'|$ . Without loss of generality, let  $u \in D$ . Then  $|D \cap V(C)| = |B|$  and  $D \cap V(G')$  is a 2-dominating set of  $G'$ . This implies

$$|D \cap V(G')| = |D| - |D \cap V(C)| + 1 < |D' \cup B| - |B| + 1 = |D'| + 1$$

and thus  $|D \cap V(G')| \leq |D'|$  and  $D \cap V(G')$  is a  $\gamma_2(G')$ -set which contains  $u$ , a contradiction to our assumption.  $\square$

The condition in Theorem 2.46 *without bridges* is sufficient but not necessary for satisfying the property  $\gamma_2 = \beta$ . Figure 2.3 shows that for cactus graphs with bridges the covering number can be much larger than the 2-domination number. However, there are indeed cactus graphs with bridges that satisfy the property  $\gamma_2 = \beta$ , as for example the graph in Figure 2.4 illustrates.

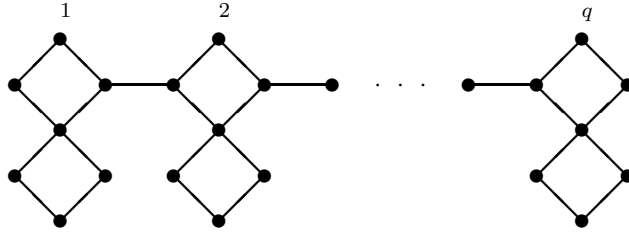

Figure 2.3:  $\gamma_2 = 3q$ ,  $\beta = 3q + \lfloor \frac{q}{2} \rfloor$ .

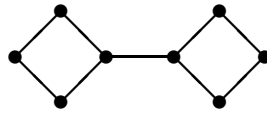

Figure 2.4: Graph with bridges and  $\gamma_2 = \beta$ .

**Corollary 2.47** (Hansberg, Volkmann [39], 2007) *Let  $G$  be a connected cactus graph without bridges. Then  $\gamma_2(G) = \gamma(G)$  if and only if  $\gamma(G) = \beta(G)$ .*

**Proof.** If  $\gamma(G) = \beta(G)$  then, because of  $\delta(G) \geq 2$ , it follows from Corollary 2.43 that  $\gamma_2(G) = \gamma(G)$ . If  $\gamma_2(G) = \gamma(G)$ , then Theorem 2.46 implies  $\gamma_2(G) = \beta(G)$  and thus  $\gamma(G) = \beta(G)$ .  $\square$

We finish this section with an observation, for which we need the following result of Bollobás and Cockayne.

**Theorem 2.48** (Bollobás, Cockayne [9], 1979) *If  $G$  is a graph without isolated vertices, then  $G$  has a minimum dominating set  $D$  such that for all  $d \in D$  there exists a neighbor  $f(d) \in V(G) - D$  of  $d$  such that  $f(d)$  is not a neighbor of a vertex  $x \in D - \{d\}$ .*

**Observation 2.49** (Hansberg, Volkmann [39], 2007) *Let  $G$  be a connected graph. If  $\gamma_2(G) = \gamma(G)$ , then  $G$  has at least two minimum dominating sets.*

**Proof.** Suppose to the contrary that  $G$  has exactly one minimum dominating set  $D$ . According to Theorem 2.48, each vertex  $d \in D$  has a neighbor  $f(d) \in (V(G) - D)$  such that  $f(d)$  is not a neighbor of a vertex  $x \in D - \{d\}$ . Thus  $f(d)$  has exactly one neighbor in  $D$  and so  $D$  is not a 2-dominating set of  $G$ . However, since  $D$  is the unique minimum dominating set of  $G$ , we conclude that  $\gamma_2(G) \geq \gamma(G) + 1$ . This contradiction completes the proof.  $\square$

### 2.3.2 Graphs with $\gamma = \gamma_2$

Now we will present the characterization of cactus, claw-free and line-graphs with equal 2-domination and domination numbers. For cactus graphs, the proof of Theorem 2.26 yields us the characterization. This result was given by Hansberg and Volkmann in [39] using a different method for the proof.

**Theorem 2.50** (Hansberg, Volkmann [39], 2007) *Let  $G$  be a cactus graph. Then  $\gamma_2(G) = \gamma(G)$  if and only if  $G$  is a  $C_4$ -cactus.*

**Proof.** (Hansberg [34]) It is easy to check that every  $C_4$ -cactus  $G$  satisfies  $\gamma(G) = \gamma_2(G)$ . Suppose now that  $\gamma_2(G) = \gamma(G)$ . Following the proof of Theorem 2.26, let  $A_i = \{a_i, b_i\}$  for  $0 \leq i \leq l$ . Since  $G$  is a cactus graph, the vertices  $a_i$  and  $b_i$  have exactly  $x_i$  and  $x'_i$  as their common neighbors and both  $x_i$  and  $x'_i$  are of degree 2 in  $G$ . Hence, the situation of Claim 4 can never occur and thus  $|A_{i+1} \cap S_i| = 1$  for all indices  $0 \leq i \leq l-1$ . We define the tree  $T$  with vertex set  $V(T) = D$  and edge set  $E(T) = \{a_i b_i \mid 0 \leq i \leq l\}$ . Now it is easy to see that  $G$  arises from  $T$  by duplicating its edges and subdividing them once (adding for each  $i$  the vertices  $x_i$  and  $x'_i$ ). Hence,  $G$  is a  $C_4$ -cactus.  $\square$

Now we center our attention on claw-free graphs. A *claw-free graph* is a graph which does not contain a  $K_{1,3}$  as an induced subgraph. The next lemma follows directly from Lemma 2.21.

**Lemma 2.51** *Let  $G$  be a connected nontrivial graph with  $\gamma_2(G) = \gamma(G)$  and let  $D$  be a minimum 2-dominating set of  $G$ . Then, for each vertex  $x \in V(G) - D$  and  $a, b \in D \cap N(x)$ , there is a vertex  $y \in V(G) - D$  such that  $x, y, a$  and  $b$  induce a  $C_4$ .*

**Lemma 2.52** *Let  $G$  be a connected nontrivial claw-free graph. If  $\gamma(G) = \gamma_2(G)$ , then every minimum 2-dominating set  $D$  of  $G$  fulfills*

- (i) *every vertex in  $V(G) - D$  has exactly two neighbors in  $D$ , and*
- (ii) *every two vertices  $a, b \in D$  have distance 2 in  $G$ .*

**Proof.** Let  $D$  be a  $\gamma_2(G)$ -set. As before,  $D$  is an independent set. Because  $G$  is claw free and  $D$  is an independent 2-dominating set, every vertex in  $V(G) - D$  has exactly two neighbors in  $D$  and thus (i) follows.

Suppose that  $a$  and  $b$  are two vertices in  $D$  such that  $d_G(a, b) > 2$ . Let  $P$  be a shortest path from  $a$  to  $b$  in  $G$  and, without loss of generality, say that  $b$  is the first vertex on  $P$  with  $d_G(a, b) > 2$ . Let  $u$  be the neighbor of  $a$  in  $P$  and  $v$  the second neighbor of  $u$  in  $P$ . Then  $u$  and  $v$  do not belong to  $D$  and both have two neighbors in  $D$ . Let  $c$  be the second neighbor of  $u$  from  $D$ . Since  $G$  is claw-free,  $v$  has to be adjacent either to  $a$  or to  $c$ . Because of the minimality of the length of  $P$ ,  $v$  cannot be adjacent to  $a$  and thus it is adjacent to another vertex from  $D$ . From the choice of the vertex  $b$ , we obtain that  $b$  is the second neighbor of  $v$  in  $D$ . Let  $S$  be the set of vertices in  $V(G) - D$  which have two neighbors from  $\{a, b, c\}$  and let  $H$  be the graph induced by the set  $S \cup \{a, b, c\}$ . Since  $d_G(a, b) > 2$ , there are no vertices which have  $a$  and  $b$  as neighbors. Further, from Lemma 2.51, we obtain that there are vertices  $u'$  and  $v'$  in  $S$  such that  $u'$  is adjacent to  $a$  and  $c$  but not to  $u$ , and  $v'$  is adjacent to  $c$  and  $b$  but not to  $v$ . Besides,  $u$  and  $v'$  cannot be adjacent for otherwise the vertices  $u, a, v, v'$  would induce a claw in  $G$ . Hence, as  $G[\{c, v', u', u\}]$  cannot be a claw,  $u'$  and  $v'$  are adjacent.

Now we will show that the set  $D' = (D - \{a, b, c\}) \cup \{u, v'\}$  is a dominating set of  $G$ . Let  $z \in V(G) - D'$ . From the construction of  $H$  and since  $D$  is 2-dominating, it is evident that if  $z \in V(G) - V(H)$ , then it has at least one neighbor in  $D - \{a, b, c\}$ . If  $z \in \{a, c, v\}$ , it has  $u$  as neighbor in  $D'$  and if  $z \in \{b, u'\}$ , it is dominated by  $v'$  in  $D'$ . It remains the case that  $z \in V(H) - \{a, b, c, u, u', v, v'\}$ . Then  $z$  has exactly either  $a$  and  $c$  or  $c$  and  $b$  as neighbors in  $\{a, b, c\}$ . Suppose that  $z$  is neighbor of  $a$  and  $c$ . In that case, it follows that  $z$  is either adjacent to  $u$  or to  $u'$ , otherwise we would have a claw. If  $z$  is adjacent to  $u$ , we are ready. If  $z$  is adjacent to  $u'$  and not to  $u$ , then  $z$  has to be adjacent to  $v'$ , otherwise  $u, z, v'$  and  $c$  would induce a claw in  $G$ . Thus,  $z$  is dominated by  $v'$  in  $D'$ . The case that  $c$  and  $b$  are neighbors

of  $z$  follows analogously. Hence,  $D'$  is a dominating set of  $G$  with less vertices than  $D$  and this is a contradiction to  $\gamma(G) = \gamma_2(G) = |D|$ . Thus, we obtain statement (ii).  $\square$

For a vertex  $x \in V$ , let  $H = (V_x, E_x)$  be a graph with  $V_x \cap V = \emptyset$ . We say that the graph  $G'$  arises by *inflating* the vertex  $x$  to the graph  $H_x$  if  $G'$  consists of the vertex set  $(V - \{x\}) \cup V_x$  and edges  $E \cup E_x \cup E'$ , where  $E' = \{uv : u \in V_x, v \in N_G(x)\}$ . The *cartesian product* of two graphs  $G_1$  and  $G_2$  is the graph  $G_1 \times G_2$  with vertex set  $V(G_1) \times V(G_2)$  and vertices  $(u_1, u_2)$  and  $(v_1, v_2)$  are adjacent if and only if either  $u_1 = v_1$  and  $u_2v_2 \in E(G_2)$  or  $u_2 = v_2$  and  $u_1v_1 \in E(G_1)$ . Let  $u$  be a vertex of  $G_1$  and  $v$  a vertex of  $G_2$ . Then the sets of vertices  $\{(u, y) \mid y \in V(G_2)\}$  and  $\{(x, v) \mid x \in V(G_1)\}$  are called a *row* and, respectively, a *column* of  $G_1 \times G_2$ . A set of vertices in  $V(G_1 \times G_2)$  is called a *transversal* of  $G_1 \times G_2$  if it contains exactly one vertex of every row and every column of  $G_1 \times G_2$ .

Let  $\mathcal{H}$  be the family of graphs such that  $G \in \mathcal{H}$  if and only if either  $G$  arises from a cartesian product  $K_p \times K_p$  of two complete graphs of order  $p$  for an integer  $p \geq 3$  by inflating every vertex but the ones on a transversal (we call it the *diagonal*) to a clique of arbitrary order, or  $G$  is a claw-free graph with  $\Delta(G) = n(G) - 2$  containing two non-adjacent vertices of maximum degree.

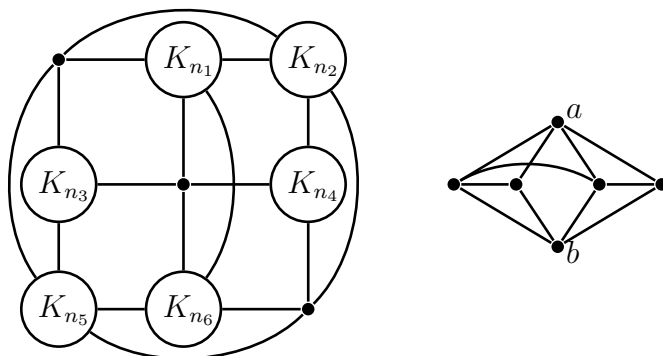

Figure 2.5: Examples of graphs from the family  $\mathcal{H}$  (here,  $n_i \in \mathbb{N}$  for  $1 \leq i \leq 6$ ).

Now we are able to present the characterization of the claw-free graphs with equal domination and 2-domination numbers.

**Theorem 2.53** *Let  $G$  be a connected claw-free graph. Then  $\gamma(G) = \gamma_2(G)$  if and only if  $G \in \mathcal{H}$ .*

**Proof.** Let  $G$  be a connected graph. It is evident that  $\Delta(G) \leq n(G) - 2$  if and only if  $\gamma(G) \geq 2$ . Hence, if  $G$  is a graph with  $\Delta(G) = n(G) - 2$  containing two non-adjacent vertices  $a$  and  $b$  with  $d_G(a) = d_G(b) = \Delta(G)$ , then every vertex  $x \in V(G) - \{a, b\}$  is adjacent to both  $a$  and  $b$ . This implies that  $2 \leq \gamma(G) \leq \gamma_2(G) \leq 2$  and so  $\gamma(G) = \gamma_2(G) = 2$ .

Let now  $p \geq 3$  be an integer and  $H$  be a graph isomorphic to the cartesian product  $K_p \times K_p$  of two complete graphs of order  $p$ ,  $T \subset V(H)$  a transversal of  $H$  and let  $G$  be a graph that arises from  $H$  by inflating every vertex  $x \in V(H) - T$  to a clique  $C_x$  of arbitrary order. Clearly, every dominating set of  $G$  has to contain vertices of every ‘‘inflated row’’ and every ‘‘inflated column’’ of  $G$  and thus  $p \leq \gamma(G)$ . Since  $T$  is a 2-dominating set of  $G$ , we obtain  $p \leq \gamma(G) \leq \gamma_2(G) \leq p$  and hence,  $\gamma(G) = \gamma_2(G) = p$ .

We prove the converse. If  $G$  is a connected graph such that  $\gamma(G) = \gamma_2(G) = 2$ , then  $\Delta(G) \leq n(G) - 2$  and every minimum 2-dominating set is independent. Hence, there are two non adjacent vertices  $a$  and  $b$  such that every other vertex is adjacent to both of them, that is,  $d_G(a) = d_G(b) = n(G) - 2 = \Delta(G)$ . Thus, if  $G$  is claw-free,  $G \in \mathcal{H}$ . Now let  $G$  be a connected claw-free graph with  $\gamma(G) = \gamma_2(G) \geq 3$ . Let  $D$  be a minimum 2-dominating set of  $G$  and let  $p = |D|$ . Since by Lemma 2.52 (ii) every two vertices of  $D$  have distance two in  $G$ , then from Lemma 2.51 it follows that each pair of vertices of  $D$  has two non-adjacent common neighbors in  $V(G) - D$ . Let  $S$  be a subset of  $V(G) - D$  which contains exactly two non-adjacent common neighbors of every pair of vertices of  $D$ . This is possible because of Lemma 2.52 (i). Let  $H$  be the subgraph induced by the vertex set  $D \cup S$ . Evidently,  $H$  is again claw-free and  $|V(H)| = |D| + 2\binom{|D|}{2} = |D|^2 = p^2$ .

*Claim 1.* Let  $v$  be a vertex in  $V(H)$ . Then the graph induced by  $N_H(v)$  consists of two disjoint cliques.

*Proof.* Assume first that  $v$  is a vertex in  $D$ . From the construction of  $H$  and since  $D$  is independent,  $v$  is adjacent to exactly  $(|D| - 1) = p - 1$  pairs of non adjacent vertices from  $S$ , such that each pair has the same two neighbors in  $D$ . Let  $x$  and  $y$  be such a pair. Let  $z$  be a neighbor of  $v$  different from  $x$  and  $y$ . As  $G$  is claw-free,  $z$  is adjacent either to  $x$  or to  $y$ . Hence,  $N_H[v] \subseteq N_H[x] \cup N_H[y]$ . Suppose that the set  $N_H[x] \cap N_H[y] \cap N_H(v)$  contains a vertex  $w$ . Let  $b$  be the second neighbor of  $x$  and  $y$  in  $D$  and  $c$  the second neighbor of  $w$  in  $D$ . Then, since  $x$ ,  $y$  and  $c$  are pairwise non adjacent, together with  $w$ , they build a claw and we obtain a contradiction. It follows that the sets  $N_H[x] \cap N_H(v)$  and  $N_H[y] \cap N_H(v)$  are disjoint. Because of  $G$  being claw-free, each of these sets is a clique. Since  $N_H(v) = (N_H[x] \cup N_H[y]) \cap N_H(v) = (N_H[x] \cap N_H(v)) \cup (N_H[y] \cap N_H(v))$ , it follows that  $H[N_H(v)]$  is the disjoint

union of two cliques.

Assume now that  $v \in S$ . Let  $a$  and  $b$  be the two neighbors of  $v$  in  $D$ . Since there is only a second vertex which is adjacent to both  $a$  and  $b$  in  $H$  and as it is not neighbor of  $v$  in  $H$ , it follows that the set  $N_H(a) \cap N_H(b) \cap N_H(v)$  is empty. As  $G$  is claw-free, the sets  $N_H[a] \cap N_H(v)$  and  $N_H[b] \cap N_H(v)$  build two disjoint cliques and, for the same reason, every other neighbor of  $v$  in  $H$  is adjacent either to  $a$  or to  $b$ . Hence,  $N_H(v) = (N_H[a] \cap N_H(v)) \cup (N_H[b] \cap N_H(v))$  and  $H[N_H(v)]$  is the disjoint union of two cliques.  $\parallel$

Let  $D = \{a_1, a_2, \dots, a_p\}$ . Let  $C_1$  and  $C_2$  be the two complete graphs induced by  $N_H[a_1]$  in  $H$  such that  $V(C_1) \cap V(C_2) = \{a_1\}$ . As  $H$  is claw-free,  $C_1$  and  $C_2$  contain exactly one vertex of each pair of non-adjacent vertices from  $S$  which have  $a_1$  and a second common neighbor in  $D$ . Then, for every vertex  $a_i \in D - \{a_1\}$ , there are vertices  $u_i \in V(C_1)$  and  $v_i \in V(C_2)$  such that  $u_i$  and  $v_i$  are common neighbors of  $a_1$  and  $a_i$ . We define  $u_1 := a_1$  and  $v_1 := a_1$ . By the construction of  $H$ , it follows that  $V(C_1) = \{u_1, u_2, \dots, u_p\}$  and  $V(C_2) = \{v_1, v_2, \dots, v_p\}$ .

*Claim 2.* For every vertex  $x \in V(H) - (V(C_1) \cup V(C_2))$  there are unique vertices  $u_x \in V(C_1)$  and  $v_x \in V(C_2)$  which are adjacent to  $x$ .

*Proof.* If  $x \in D$ , then  $x = a_i$  for some  $2 \leq i \leq |D|$  and, from the construction of  $H$ ,  $x$  has exactly  $u_i \in V(C_1)$  and  $v_i \in V(C_2)$  as neighbors. Let  $x \in V(H) - (V(C_1) \cup V(C_2) \cup D)$ . Then  $x$  has two neighbors  $a_i$  and  $a_j$  in  $D$ , where  $2 \leq i < j \leq p$ . Let  $C_{u_i}$  and  $C_{v_i}$  be the cliques induced by  $N_H[a_i]$  such that  $u_i$  is contained in the first one and  $v_i$  in the second (see Claim 1). Analogously, define  $C_{u_j}$  and  $C_{v_j}$ . Then  $x$  is either neighbor of  $u_i$  or neighbor of  $v_i$ . By the same manner,  $x$  is either neighbor of  $u_j$  or of  $v_j$ . Now we will show that the set  $V(C_{u_i}) \cap V(C_{u_j})$  is empty. Suppose to the contrary that  $x \in V(C_{u_i}) \cap V(C_{u_j})$ . Applying again Claim 1, we obtain that  $x \notin V(C_{v_i})$  and  $x \notin V(C_{v_j})$ . Let  $y$  be the second vertex from  $S$  that is adjacent to both  $a_i$  and  $a_j$ . Since  $x$  and  $y$  are not adjacent, it follows that  $y \in V(C_{v_i}) \cap V(C_{v_j})$ . We will now prove that  $D' := (D - \{a_1, a_i, a_j\}) \cup \{x, v_j\}$  is a dominating set of  $G$ .

Let  $w \in V(G) - D'$ . If  $w \in \{a_1, a_i, a_j\}$ , then  $w$  is either adjacent to  $x$  or to  $v_j$ . Thus suppose that  $w \in V(G) - (D \cup \{x, v_j\})$ . Since  $D$  is a 2-dominating set,  $w$  has 2 neighbors in  $D$ . If one of these two neighbors is different from  $a_1$ ,  $a_i$  and  $a_j$ , then  $w$  has a neighbor in  $D'$ . So we can assume that  $w$  has two neighbors in  $\{a_1, a_i, a_j\}$ . Suppose that  $a_1$  and  $a_i$  are neighbors of  $w$ . Then  $w \in V(C_{v_j})$  or  $w \in V(C_{u_i})$ . Since  $v_j \in V(C_{v_j})$  and  $x \in V(C_{u_i})$ ,  $w$  is dominated either by  $v_j$  or by  $x$  in  $D'$ . The other cases that

$a_1$  and  $a_j$  or rather  $a_i$  and  $a_j$  are neighbors of  $w$  follow similarly. Hence,  $D'$  is a dominating set of  $G$  with less vertices than  $D$ , a contradiction to the hypothesis that  $|D| = \gamma_2(G) = \gamma(G)$ .

Thus,  $V(C_{u_i}) \cap V(C_{u_j}) = \emptyset$ . Analogously, we obtain that  $V(C_{v_i}) \cap V(C_{v_j}) = \emptyset$ . Hence,  $x$  is adjacent either to  $u_i$  and to  $v_j$  or to  $u_j$  and to  $v_i$  but not to more than two of them. It follows that every vertex  $x \in V(H) - (V(C_1) \cup V(C_2))$  has unique neighbors  $u_x \in V(C_1)$  and  $v_x \in V(C_2)$  and Claim 2 is proved.  $\parallel$

Now we can define the mapping

$$\begin{aligned} \phi : V(H) &\longrightarrow V(C_1 \times C_2) : u_i \mapsto (u_i, v_1), \text{ for } u_i \in V(C_1) \\ &v_i \mapsto (u_1, v_i), \text{ for } v_i \in V(C_2) \\ &x \mapsto (u_x, v_x), \text{ otherwise.} \end{aligned}$$

*Claim 3.* Let  $x$  and  $y$  be two vertices in  $V(H)$  and let  $\phi(x) = (u_i, v_j)$  and  $\phi(y) = (u_l, v_m)$ . Then  $x$  and  $y$  are adjacent if and only if  $i = l$  or  $j = m$ .

*Proof.* Suppose that  $x$  is neighbor of  $y$ . From the definition of the mapping  $\phi$  we have that  $x$  is adjacent to  $u_i$  and  $v_j$  and that  $y$  is adjacent to  $u_l$  and  $v_m$ . From Claim 1 it follows that  $y$  is adjacent either to  $u_i$  or to  $v_j$ . This implies that  $i = l$  or  $j = m$ .

Conversely, if  $i = l$  or  $j = m$ , it follows again by Claim 1 that  $x$  and  $y$  are in a clique together with either  $u_i = u_l$  or with  $v_j = v_m$ .  $\parallel$

*Claim 4.* The mapping  $\phi$  is bijective.

*Proof.* Let be  $x$  and  $y$  two vertices from  $V(H) - (V(C_1) \cup V(C_2))$  such that  $\phi(x) = (u_i, v_j) = \phi(y)$ . Let  $C_{u_i}$  and  $C_{v_j}$  be like in Claim 3. Then  $x$  and  $y$  are contained in  $V(C_{u_i}) \cup V(C_{v_j})$ . By Claim 1, we obtain that  $\{x\} = V(C_{u_i}) \cap V(C_{v_j}) = \{y\}$  and thus  $x = y$ . Hence,  $\phi$  is injective. Since

$$\begin{aligned} |V(H) - (V(C_1) \cup V(C_2))| &= |D|^2 - 2|D| + 1 = (|D| - 1)^2 \\ &= |(V(C_1) - \{u_1\}) \times (V(C_2) - \{v_1\})|, \end{aligned}$$

it follows that  $\phi$  is bijective.  $\parallel$

From Claims 3 and 4 it follows that  $H \cong C_1 \times C_2 \cong K_p \times K_p$ . Because  $D$  is a dominating set of  $H$  with  $|D| = p$ , evidently it is a transversal of  $H$ .

Let  $x$  be a vertex in  $V(G) - V(H)$  and let  $a$  and  $b$  be the neighbors of  $x$  in  $D$ . Then  $H$  contains exactly two non-adjacent vertices  $u$  and  $v$  having

both  $a$  and  $b$  as neighbors. As  $G$  is claw-free,  $x$  is either adjacent to  $u$  or to  $v$ . Without loss of generality, say that  $x$  is adjacent to  $u$ .

*Claim 5.* The graph induced by the set  $(V(H) - \{u\}) \cup \{x\}$  is again isomorphic to  $K_p \times K_p$ .

*Proof.* From Lemma 2.52 (ii), there is a vertex  $y$  in  $G$  that is not adjacent to  $u$  but to  $a$  and  $b$ . Note that the set  $V(H) - D$  is an arbitrary set such that it has exactly two non-adjacent common neighbors of every pair of vertices of  $D$ . Hence, we could exchange  $u$  and  $v$  by  $x$  and  $y$  in  $H$  and we would obtain again a graph isomorphic to  $K_p \times K_p$ . This implies that  $x$  has the same neighbors in  $V(H) - \{u, v\}$  as  $u$ . Suppose that  $x$  is adjacent to  $v$ . Since  $p \geq 3$ , there are two vertices  $u_1$  and  $u_2$  in  $N_H(u)$  such that  $u_1, u_2$  and  $v$  lie pairwise on different columns and rows. Then, non of these three vertices are adjacent to each other and, hence, together with  $x$ , they form a claw. This implies that  $x$  is not adjacent to  $v$  and so, without loss of generality, we can say that  $y = v$ . We obtain now that the set  $(V(H) - \{u\}) \cup \{x\}$  induces again a graph  $K_p \times K_p$  and the claim is proved.  $\parallel$

It is now easy to see that, for every vertex  $u \in V(H) - D$ , the set  $(N_G(u) - V(H)) \cup \{u\}$  induces a clique  $C_u$  in  $G$  and that  $N_G[x] = N_G[u]$  for every vertex  $x \in N_G(u) - V(H)$ . Hence, if we melt all vertices of every clique  $C_u$  for each vertex  $u \in V(H) - D$  to a unique vertex  $\hat{u}$ , we obtain a graph  $\hat{H}$  isomorphic to  $K_p \times K_p$ . Reverting the process, that is, inflating each vertex  $\hat{u}$  to the original clique  $C_u$ , we obtain again  $G$ . Therefore  $G \in \mathcal{H}$ .  $\square$

If  $G$  is a graph, then the *line graph* of  $G$ , usually denoted by  $\mathcal{L}(G)$ , is obtained by associating one vertex to each edge of  $G$ , and two vertices of  $\mathcal{L}(G)$  being joined by an edge if and only if the corresponding edges in  $G$  are incident to each other. If, for a graph  $G$ , there is a graph  $G'$  whose line graph is isomorphic to  $G$ , then we say that  $G$  is a *line graph*. In 1943, Krausz presented the following characterization of line graphs.

**Theorem 2.54** (Krausz [51], 1943) *A graph  $G$  is a line graph if and only if it can be partitioned into edge disjoint complete graphs such that every vertex of  $G$  belongs to at most two of them.*

In 1968, Beineke [4] obtained a characterization of line graphs in terms of nine forbidden induced subgraphs. In Figure 2.6, we present three of the forbidden induced subgraphs, to which we will refer.

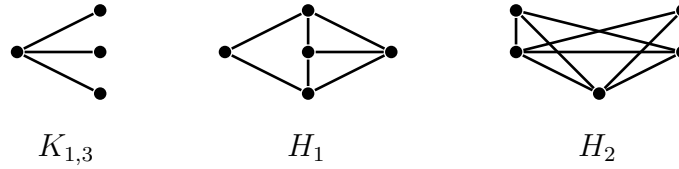
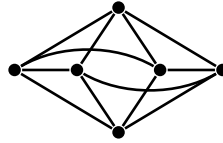

Figure 2.6: Three forbidden induced subgraphs in line graphs.

Since the claw is one of those subgraphs, every line graph is claw-free. Thus the characterization of the line graphs with equal domination and 2-domination numbers follows from the one of claw-free graphs.

**Theorem 2.55** *Let  $G$  be a line graph. Then  $\gamma_2(G) = \gamma(G)$  if and only if  $G$  is either the cartesian product  $K_p \times K_p$  of two complete graphs of the same cardinality  $p$  or  $G$  is isomorphic to the graph  $J$  depicted in Figure 2.7.*

Figure 2.7: Graph  $J$ 

**Proof.** Since every line graph is claw-free, the set of line graphs with  $\gamma = \gamma_2$  is contained in  $\mathcal{H}$ . If  $G$  is a cartesian product of two complete graphs  $K_p$  for an integer  $p \geq 2$ , then the graphs induced by the vertices of every row and of every column of  $G$  are complete graphs  $K_p$  and form a partition of  $G$  in edge disjoint complete subgraphs such that every vertex of  $G$  is contained in at most two of them. Hence, by Theorem 2.54,  $G$  is a line graph. If  $G \cong J$ , it is not difficult to obtain a partition of the graph  $J$  in edge disjoint complete subgraphs such that every vertex of  $J$  is contained in at most two of them and thus  $J$  is a line graph.

Conversely, suppose that  $G \in \mathcal{H}$  is a line graph.

*Case 1.* Assume that  $G$  is a cartesian product  $K_p \times K_p$  of two complete graphs of order  $p$  for an integer  $p \geq 2$  such that the vertices not in a certain transversal  $T$  of  $G$  are inflated into a clique of arbitrary order. Let  $a$  and  $b$  be two elements of  $T$  and  $C_1$  and  $C_2$  the two inflated vertices which are neighbors of both  $a$  and  $b$ . Suppose that  $C_1$  has order at least 2 and let  $x$  and  $y$  be vertices in  $C_1$  and  $z$  a vertex in  $C_2$ . It is now easy to see that the vertices  $a, b, x, y$  and  $z$  induce the graph  $H_1$  of Figure 2.6. Hence,  $G$

cannot be a line graph, which contradicts our hypothesis. Thus,  $G$  contains no inflated vertices, that is, it is a cartesian product of two complete graphs of order  $p \geq 2$ .

*Case 2.* Assume that  $G$  is a graph of maximum degree  $\Delta(G) = n(G) - 2$  containing two non-adjacent vertices  $a$  and  $b$  such that every vertex  $x \in V(G)$  is adjacent to both  $a$  and  $b$ . If  $n(G) = 4$ , then obviously it is a  $C_4$  and thus isomorphic to  $K_2 \times K_2$ . Since the only claw-free graph in  $\mathcal{H}$  of order 5 is isomorphic to  $H_1$ , which is not a line graph, we can assume that  $n(G) \geq 6$ . Since  $\Delta(G) = n(G) - 2$ , there are two non adjacent vertices  $x$  and  $y$  different from  $a$  and  $b$ . Let  $z \in V(G) - \{a, b, x, y\}$ . Since  $G$  is claw-free and every vertex in  $V(G) - \{a, b\}$  is adjacent to both  $a$  and  $b$ , without loss of generality, we can suppose that  $z$  is neighbor of  $x$ . If  $z$  is not adjacent to  $y$ , the vertices  $a, b, x, z$  and  $y$  would induce a graph isomorphic to  $H_1$  and  $G$  would not be a line graph. Hence,  $z$  is neighbor of  $y$ . Since  $\Delta(G) = n(G) - 2$ , there is another vertex  $z'$  which is not adjacent to  $z$ , but, analogously, adjacent to  $x$  and  $y$  and of course to  $a$  and  $b$ . If  $n(G) = 6$ , we are ready and  $G \cong J$ . If  $n(G) \geq 7$ , then there is another vertex  $w$  adjacent to  $x, y, z$  and  $z'$  (with the same arguments as before). But then, the vertices  $a, b, x, z$  and  $w$  induce a graph isomorphic to  $H_2$  of Figure 2.6 and  $G$  is not a line graph. Therefore,  $G$  cannot have order greater than 6 and, thus, the only possibility for  $G$  is being isomorphic to the graph  $J$ .

It follows that  $\gamma_2(G) = \gamma(G)$  if and only if  $G$  is either the cartesian product  $K_p \times K_p$  of two complete graphs of the same cardinality  $p \geq 2$  or  $G$  is isomorphic to the graph  $J$  of Figure 2.7.  $\square$



# Chapter 3

## The $k$ -domination number and other parameters

In this chapter, we will present several results concerning  $k$ -domination and other graph parameters like the independence number, the chromatic number, the independent domination number  $i$ , the matching number, the connected domination number and the total domination number.

### 3.1 Independence and $k$ -domination in graphs

We start with the independence number  $\alpha$  and the following theorem.

**Theorem 3.1** (Hansberg, Meierling, Volkmann [36]) *If  $G$  is a connected graph of order  $n$  with  $\delta(G) \leq q - 1$  and  $\Delta(G) \leq q$  for an integer  $q \geq 1$ , then*

$$\alpha(G) \geq \frac{n}{q}.$$

**Proof.** For  $q = 1$  it is trivial. If  $1 \leq n \leq q$ , the statement is clear. Assume now that  $n > q \geq 2$ . Let  $x$  be a vertex of  $G$  of minimum degree  $\delta(G)$  and let  $G'$  be the graph  $G - N_G[x]$ . Since  $n > q$  and  $|N_G[x]| \leq q$ ,  $V(G')$  is not empty. Let  $Q_1, Q_2, \dots, Q_s$  be the components of  $G'$ . Then  $\Delta(Q_i) \leq q$  for all  $1 \leq i \leq s$  and, since  $G$  is connected and  $\Delta(G) \leq q$ , it is evident that  $\delta(Q_i) \leq q - 1$  for  $1 \leq i \leq s$ . Thus, by the induction hypothesis, it follows that  $\alpha(Q_i) \geq \frac{n(Q_i)}{q}$  for  $1 \leq i \leq s$ . Let  $I$  be a maximum independent set of  $G'$ . Then  $I \cap V(Q_i)$  is a maximum independent set for each  $Q_i$  and  $I \cup \{x\}$  is an independent set of  $G$ . Now we obtain

$$\begin{aligned}
 \alpha(G) &\geq 1 + |I| = 1 + \sum_{i=1}^s \alpha(Q_i) \\
 &\geq 1 + \sum_{i=1}^s \frac{n(Q_i)}{q} = 1 + \frac{n(G')}{q} = 1 + \frac{n - \delta(G) - 1}{q} \\
 &\geq 1 + \frac{n - q}{q} = \frac{n}{q},
 \end{aligned}$$

and the proof is complete. □

In 1941, Brooks presented the following theorem.

**Theorem 3.2** (Brooks [10], 1941) *If  $G$  is a connected graph different from the complete graph and from a cycle of odd length, then  $\chi(G) \leq \Delta(G)$ .*

Brooks' Theorem and the well-known inequality  $\alpha(G) \geq \frac{n(G)}{\chi(G)}$  for a graph  $G$  imply that, if  $G$  is neither the complete graph nor a cycle of odd length, then  $\alpha(G) \geq \frac{n(G)}{\Delta(G)}$ . From Theorem 3.1, this inequality follows only for non-regular graphs. Another bound for  $\alpha$  with respect to the degrees of the vertices of a graph was given by Wei in 1980.

**Theorem 3.3** (Wei [72], 1980) *If  $G$  is a graph, then*

$$\alpha(G) \geq \sum_{x \in V(G)} \frac{1}{d_G(x) + 1}.$$

For regular graphs, Theorem 3.1 and Wei's Theorem lead to the same bound for  $\alpha$ . For semiregular graphs, our bound in Theorem 3.1 is even better as Wei's bound. In other cases, Brooks' and Wei's theorems can achieve better bounds for  $\alpha$ . However, if no facts about the degree of the vertices are known and the possibility of the graph being isomorphic to  $K_n$  or to an odd cycle cannot be excluded, Theorem 3.1 is better applicable.

Now we proceed with some results about the  $k$ -domination number.

**Theorem 3.4** (Hansberg, Meierling, Volkmann [36]) *Let  $G$  be an  $r$ -partite graph of order  $n$ . If  $k$  is a positive integer, then*

$$\gamma_k(G) \leq \frac{(r - 1)n + |\{x \in V(G) : d_G(x) \leq k - 1\}|}{r}.$$

**Proof.** If  $S \subseteq V(G)$  is a set of vertices of degree at most  $k - 1$ , then  $S$  is contained in every  $\gamma_k(G)$ -set. In the case that  $|S| = |V(G)| = n$ , we are done. In the remaining case that  $|S| < |V(G)|$ , let  $V_1, V_2, \dots, V_r$  be a partition of the  $r$ -partite graph  $G[V(G) - S]$  such that  $|V_1| \geq |V_2| \geq \dots \geq |V_r|$ , where  $V_i = \emptyset$  is possible for  $i \geq 2$ . Then every vertex of  $V_1$  has degree at least  $k$  and all its neighbors are in  $V(G) - V_1$ . Thus  $V(G) - V_1$  is a  $k$ -dominating set of  $G$  such that

$$|V_1| \geq \frac{|V_1| + |V_2| + \dots + |V_r|}{r} = \frac{n - |S|}{r}$$

and thus

$$\gamma_k(G) \leq |V(G) - V_1| = n - |V_1| \leq n - \frac{n - |S|}{r} = \frac{(r - 1)n + |S|}{r}.$$

This completes the proof of Theorem 3.4.  $\square$

**Corollary 3.5** (Blidia, Chellali, Volkmann [8], 2006) *Let  $k$  be a positive integer. If  $G$  is a bipartite graph of order  $n$ , then*

$$\gamma_k(G) \leq \frac{n + |\{x \in V(G) : d_G(x) \leq k - 1\}|}{2}.$$

**Theorem 3.6** (Hansberg, Meierling, Volkmann [36]) *If  $G$  is a connected  $r$ -partite graph and  $k$  is an integer such that  $\Delta(G) \geq k$ , then*

$$\gamma_k(G) \leq \frac{\alpha(G)}{r}((r - 1)r + k - 1).$$

**Proof.** If  $k = 1$ , the statement follows from the fact that  $\alpha(G) \geq \frac{n(G)}{r}$  and Theorem 3.4. Assume now that  $k \geq 2$ . Let  $S := \{x \in V(G) : d_G(x) \leq k - 1\}$ . Since  $G$  is connected and  $V(G) - S$  is not empty, every component  $Q$  of  $G[S]$  fulfills  $\delta(Q) \leq k - 2$  and  $\Delta(Q) \leq k - 1$ . From Theorem 3.1, it follows that  $\alpha(Q) \geq n(Q)/(k - 1)$ . Thus, if  $Q_1, Q_2, \dots, Q_s$  are the components of  $G[S]$ , then we obtain  $\alpha(G) \geq \alpha(G[S]) \geq \sum_{i=1}^s \alpha(Q_i) \geq n(G[S])/(k - 1) = |S|/(k - 1)$ . Together with  $n(G) \leq r\alpha(G)$ , Theorem 3.4 implies

$$\begin{aligned} \gamma_k(G) &\leq \frac{(r - 1)n(G) + |S|}{r} \\ &\leq \frac{(r - 1)r\alpha(G) + (k - 1)\alpha(G)}{r} \\ &= \frac{\alpha(G)}{r}((r - 1)r + k - 1). \end{aligned}$$

$\square$

**Corollary 3.7** (Hansberg, Meierling, Volkmann [36]) *If  $G$  is a connected bipartite graph with  $\Delta(G) \geq k$ , then*

$$\gamma_k(G) \leq \frac{(k+1)\alpha(G)}{2}.$$

**Corollary 3.8** (Blidia, Chellali, Favaron [6], 2005) *If  $T$  is a tree of order  $n \geq 3$ , then*

$$\gamma_2(T) \leq \frac{3\alpha(T)}{2}.$$

Blidia, Chellali and Favaron also characterized the trees satisfying equality in the previous corollary. This demonstrates that the inequality given in Theorem 3.6 is sharp for the case that  $r = 2$  and  $k = 2$ . In the next section, we will center our attention in the special case  $k = 2$ .

**Corollary 3.9** (Hansberg, Meierling, Volkmann [36]) *Let  $G$  be an  $r$ -partite graph of order  $n$ . If  $k$  is a positive integer and  $\delta(G) \geq k$ , then*

$$\gamma_k(G) \leq (r-1)\alpha(G).$$

**Proof.** Since  $n \leq r\alpha(G)$ , this result immediately follows from Theorem 3.4. □

Since every graph  $G$  is  $\chi(G)$ -partite, we obtain following corollaries from Theorems 3.4 and 3.6 and Corollary 3.9.

**Corollary 3.10** (Hansberg, Meierling, Volkmann [36]) *If  $G$  is a graph of order  $n$  and  $k$  a positive integer, then*

$$\gamma_k(G) \leq \frac{(\chi(G) - 1)n + |\{x \in V(G) : d_G(x) \leq k - 1\}|}{\chi(G)}.$$

**Corollary 3.11** (Hansberg, Meierling, Volkmann [36]) *Let  $G$  be a connected graph with  $\Delta(G) \geq k$ . Then*

$$\gamma_k(G) \leq \frac{\alpha(G)}{\chi(G)}((\chi(G) - 1)\chi(G) + k - 1).$$

**Corollary 3.12** (Hansberg, Meierling, Volkmann [36]) *Let  $G$  be a graph with  $\delta(G) \geq k$  for a positive integer  $k$ . Then*

$$\gamma_k(G) \leq (\chi(G) - 1)\alpha(G).$$

Combining Brooks' Theorem and Corollary 3.12, we obtain the following theorem.

**Theorem 3.13** (Hansberg, Meierling, Volkmann [36]) *Let  $G$  be a connected nontrivial graph with maximum degree  $\Delta$  and let  $k$  be a positive integer such that  $\delta(G) \geq k$ . If  $G$  is neither isomorphic to a cycle of odd length, if  $k = 2$ , nor to the complete graph  $K_{k+1}$ , then*

$$\gamma_k(G) \leq (\Delta - 1)\alpha(G).$$

**Proof.** If  $k = 1$  and  $G$  is neither the  $K_1$  nor the  $K_2$ , then  $\Delta \geq 2$  and hence, from the well-known property  $\gamma(G) \leq \alpha(G)$  for every connected graph  $G$ ,  $\gamma(G) \leq (\Delta - 1)\alpha(G)$  follows. Assume now that  $k > 1$ . If  $G$  is the complete graph  $K_n$ , then  $\Delta = n - 1$ ,  $\delta(G) = n - 1 \geq k \geq 2$ ,  $\gamma_k(G) = k$  and  $\alpha(G) = 1$ . Consequently,  $\gamma_k(G) \leq (\Delta - 1)\alpha(G)$  if and only if  $n \geq k + 2$ , that is, if  $n \neq k + 1$ . For all other graphs not isomorphic to a cycle of odd length, the statement follows directly from Brooks' theorem and Corollary 3.12.  $\square$

Next, we will characterize the graphs  $G$  with  $\alpha(G) = n(G)/\Delta(G)$ .

**Theorem 3.14** (Hansberg, Meierling, Volkmann [36]) *Let  $G$  be a connected graph of order  $n$  with  $\delta(G) \leq q - 1$  and  $\Delta(G) \leq q$  for an integer  $q \geq 2$ . Then  $\alpha(G) = \frac{n}{q}$  if and only if  $\delta(G) = q - 1$  and*

- (i)  $G$  consists of several cliques of order  $q$  connected by a matching, or
- (ii)  $q = 3$  and  $G$  consists of several graphs isomorphic to  $H_1$ , to  $H_2$ , to  $H_3$  (illustrated in Figure 3.1) or to the complete graph  $K_3$ , all of them connected by a matching, or
- (iii)  $q = 4$  and  $G$  consists of several graphs isomorphic to  $H_4$  (illustrated in Figure 3.1) or to the complete graph  $K_4$ , all of them connected by a matching.

**Proof.** Let  $q \geq 2$  and let  $G$  be a graph with  $\delta(G) \leq q - 1$  and  $\Delta(G) \leq q$  such that it has one of the structures described in the theorem. Let  $Q_1, Q_2, \dots, Q_s$  be the subgraphs of  $G$  that are, like described, connected by a matching. It is easy to see that  $\alpha(H_i) = \frac{n(H_i)}{3}$  for  $1 \leq i \leq 3$  and  $\alpha(H_4) = \frac{n(H_4)}{4}$  and evidently  $\alpha(K_q) = \frac{n(K_q)}{q} = 1$ . Thus,

$$\alpha(G) \leq \sum_{i=1}^s \alpha(Q_i) = \sum_{i=1}^s \frac{n(Q_i)}{q} = \frac{n}{q}$$

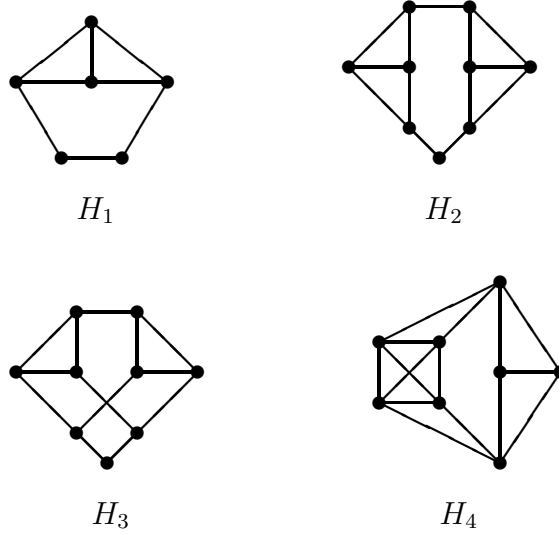

Figure 3.1: Graphs  $H_1$ ,  $H_2$ ,  $H_3$  and  $H_4$ .

and with Theorem 3.1 we obtain  $\alpha(G) = \frac{n}{q}$ .

Conversely, assume now that  $G$  is a connected graph with  $\delta(G) \leq q - 1$  and  $\Delta(G) \leq q$  and such that  $\alpha(G) = \frac{n(G)}{q}$  for an integer  $q \geq 2$ . If  $\alpha(G) = 1$ , then it is evident that  $G \cong K_q = K_n$  and that  $\delta(G) = q - 1$ . If  $q = 2$ , then  $G$  is a path of order  $n = 2\alpha(G)$ . Suppose now that  $\alpha(G) \geq 2$  and  $q \geq 3$ . As in the proof of Theorem 3.1, let  $x$  be a vertex of degree  $\delta(G)$ , let  $G'$  denote the graph  $G - N_G[x]$  and let  $Q_1, Q_2, \dots, Q_s$  be the components of  $G'$ . Following the proof of this theorem, we must have equality in the given inequality chain. This implies that  $\delta(G) = q - 1$  and  $\alpha(Q_i) = \frac{n(Q_i)}{q}$  for each component  $Q_i$  of  $G'$ . Again for each component  $Q_i$  we have  $\delta(Q_i) = q - 1$  and, by the induction hypothesis, they have one of the structures (i) - (iii). Before continuing with the proof, we will first verify the following claims.

*Claim 1.* If  $F$  is a connected graph with structure like described in the theorem, then, for each vertex  $u \in V(F)$  of degree  $q - 1$ , there is a maximum independent set  $I$  containing  $u$  and such that every vertex in  $I - \{u\}$  is of degree  $q$ .

*Proof.* We will prove the claim by induction on the number of graphs  $F_1, F_2, \dots, F_r$  isomorphic to  $K_q$  for  $q \geq 2$  or to  $H_1, H_2$  or  $H_3$ , if  $q = 3$ , or to  $H_4$ , if  $q = 4$ , such that they are connected by a matching. If  $r = 1$ , then the claim is easy to verify. If  $r \geq 2$ , then there is a vertex  $u$  of degree  $d_F(u) = q - 1$

contained in one of the graphs  $F_1, F_2, \dots, F_r$ , say, without loss of generality, in  $F_r$ . Now consider the graph  $F' := F - V(F_r)$  and let  $C_1, C_2, \dots, C_s$  be its components. Since every component  $C_i$  of  $F'$ , for  $1 \leq i \leq s$ , has the same structure like  $F$  but with less graphs connected by a matching, we can apply the induction hypothesis on it. Also, for every  $C_i$  there is a vertex  $u_i$  with  $d_{C_i}(u_i) = q - 1$  that is adjacent to a vertex of  $F_r$ . It follows that for every  $C_i$  there is either a maximum independent set  $I_i$  with only vertices of degree  $q$  or there is a maximum independent set  $I_i$  containing  $u_i$  such that all vertices in  $I_i - \{u_i\}$  have degree  $q$  in  $C_i$  and thus also in  $F$ .

Further, if  $q = 3$  and  $F_r \cong H_j$  for  $j \in \{1, 2, 3\}$  or, if  $q = 4$  and  $F_r \cong H_4$ , it is easy to see that there is a maximum independent set  $I'$  of  $F_r$  containing  $u$  and such that  $I' - \{u\}$  has only vertices of degree  $q$ . In such a case define  $I := \bigcup_{i=1}^s I_i \cup I'$ . If  $q \geq 2$  and  $F_r \cong K_q$ , then define  $I := \bigcup_{i=1}^s I_i \cup \{u\}$ . In both cases  $I$  is a maximum independent set of  $F$  containing  $u$  such that  $I - \{u\}$  contains only vertices of degree  $q$ .  $\parallel$

*Claim 2.* If  $F$  is a connected graph of a structure like in (i) for an integer  $q \geq 2$  and there are at least  $2\alpha(F)$  vertices of degree  $q$  in  $F$ , then there is a maximum independent set  $I$  of  $F$  with only vertices of degree  $q$ .

*Proof.* Let  $\mathcal{C}$  be the set of cliques which compose the graph  $F$  and  $M$  the matching which connects them. For a vertex  $x \in V(F)$ , we denote with  $C_x$  the clique to which  $x$  belongs. Define  $\mathcal{F}$  as the multigraph with vertex set  $V(\mathcal{F}) = \mathcal{C}$  and edge set  $E(\mathcal{F}) = \{C_x C_y \mid xy \in M\}$ , where  $C_x C_y$  represents an edge between the cliques  $C_x$  and  $C_y$ . Let  $\mathcal{T}$  be a spanning tree of  $\mathcal{F}$ . Since  $F$  has at least  $2\alpha(F)$  vertices of degree  $q$  (those which are incident to an edge from  $M$ ), it follows that  $\mathcal{F}$  has at least  $\alpha(F)$  edges and, hence, there is at least one edge  $C_u C_v \in E(\mathcal{F})$  that does not belong to  $\mathcal{T}$ . We call  $C_u$  the *root* of  $\mathcal{T}$  and define the mapping  $g : E(\mathcal{F}) \rightarrow V(F)$  by

$$g(C_x C_y) = \begin{cases} x, & \text{if } d_{\mathcal{T}}(C_u, C_x) > d_{\mathcal{T}}(C_u, C_y) \\ y, & \text{otherwise.} \end{cases}$$

It is now easy to see that the set  $I = \{g(C_x C_y) \mid C_x C_y \in E(\mathcal{T})\} \cup \{u\}$  contains exactly one vertex of every clique of  $\mathcal{C}$  and that it is an independent set of  $F$  of cardinality  $\alpha(F)$  such that  $d_F(x) = q$  for all  $x \in I$ .  $\parallel$

*Claim 3.* If  $F$  is a connected graph of a structure like in (ii) or (iii) for  $q = 3$  and, respectively,  $q = 4$  but not like in (i), then there is a maximum independent set of  $F$  with only vertices of degree  $q$ .

*Proof.* If  $F \cong H_i$  for an  $i \in \{1, 2, 3, 4\}$  and respective  $q \in \{3, 4\}$ , then it is obvious that there is a maximum independent set of  $F$  with only vertices of degree  $q$ . Suppose now that  $F$  consists of at least two subgraphs connected by a matching. Since  $F$  has not the structure from (i), there is a subgraph  $H$  that is isomorphic to a  $H_i$  for  $i \in \{1, 2, 3, 4\}$ . Note that there are at most two vertices of degree  $q - 1$  in  $H$  and thus the graph  $F - V(H)$  has at most two components which have one of the structures of the theorem. From Claim 1, we can choose for each component of  $F - V(H)$  a maximum independent set of only vertices of degree  $q$  or containing the vertices that are incident to a matching edge that connects them with  $H$  and else only vertices of degree  $q$ . Since  $H$  has also a maximum independent set with only vertices of degree  $q$ , all these independent sets build together a maximum independent set of  $F$  with only vertices of degree  $q$ .  $\parallel$

*Claim 4.* If  $y$  and  $z$  are non-adjacent vertices from  $N_G(x)$ , then there is a component  $Q$  of  $G'$  with  $\alpha(Q) \leq 2$  and structure like in (i) and such that  $|N_G(\{y, z\})| \geq q$ .

*Proof.* If all components  $Q_i$  of  $G'$ ,  $1 \leq i \leq s$ , are either isomorphic to a  $H_i$ , for  $i \in \{1, 2, 3, 4\}$ , or they have  $2\alpha(Q_i)$  vertices of degree  $q$  in  $Q_i$ , then, by Claims 2 and 3, there is for each component  $Q_i$  a maximum independent set  $I_i$  with only vertices of degree  $q$  in  $Q_i$ , which together with  $\{y, z\}$  build an independent set of  $G$  with  $1 + \sum_{i=1}^s \alpha(Q_i) = 1 + \alpha(G)$  vertices, a contradiction. Thus, there is a partition  $S \cup R$  of  $\{1, 2, \dots, s\}$ , with  $S \neq \emptyset$ , such that every component  $Q_j$ , for  $j \in S$ , has structure like in (i) and has at most  $2\alpha(Q_j) - 2$  vertices of degree  $q$  in  $Q_j$  and every component  $Q_i$ , for  $i \in R$ , has at least  $2\alpha(Q_i)$  vertices of degree  $q$  in  $Q_i$ . Let  $\tilde{I}_i$  be a maximum independent set of  $Q_i$  with only vertices of degree  $q$  in  $Q_i$  for  $i \in R$ . Suppose now that for all  $j \in S$  there is a vertex  $v_j \in V(Q_j) - N_G(\{y, z\})$  with  $d_{Q_j}(v_j) = q - 1$ . Then, from Claim 1, it follows that there are maximum independent sets  $\hat{I}_j$  of  $Q_j$  with  $v_j \in \hat{I}_j$  and such that all vertices from  $\hat{I}_j - \{v_j\}$  are of degree  $q$  in  $Q_j$ . But then

$$\bigcup_{j \in S} \hat{I}_j \cup \bigcup_{i \in R} \tilde{I}_i \cup \{y, z\}$$

is an independent set of  $G$  with  $\alpha(G) + 1$  vertices, a contradiction. Therefore, there has to exist a component  $Q$  in  $G'$  with structure like in (i), with at most  $2\alpha(Q) - 2$  vertices of degree  $q$  in  $Q$  and such that the vertices of degree  $q - 1$  in  $Q$  are all contained in  $N_G(\{y, z\})$ . It follows that

$$2q - 2 \geq |N_G(\{y, z\}, Q)| \geq n(Q) - (2\alpha(Q) - 2) = (q - 2)\alpha(Q) + 2 \geq q,$$

which implies  $q(\alpha(Q) - 2) \leq 2(\alpha(Q) - 2)$  and thus, since  $q \geq 3$ , we obtain  $\alpha(Q) \leq 2$  and we are done.  $\parallel$

Now we proceed further with the proof of the theorem.

If all vertices of  $N_G(x)$  are pairwise adjacent, then  $G[N_G[x]] \cong K_q$  and it is immediate that  $G$  has the desired structure. Thus, assume now that there are two vertices  $y$  and  $z$  in  $N_G(x)$  that are not adjacent. From Claim 4, it follows that there is a component  $Q$  of  $G'$  with  $\alpha(Q) \leq 2$  and structure like in (i) and such that  $|N_G(\{y, z\}, Q)| \geq q$ . Suppose first that  $\alpha(Q) = 2$ . Then the inequality given in Claim 4 implies that  $|N_G(\{y, z\}, Q)| = 2q - 2$  and thus  $y$  and  $z$  have no neighbors in  $N_G(x)$ . This implies that  $Q$  consists of two cliques  $K_q$  joined by a single edge and that  $|N_G(y, Q)| = |N_G(z, Q)| = q - 1$ . If  $q = 3$ ,  $N_G(x) = \{y, z\}$  and it is a simple matter to verify that  $G$  is isomorphic to  $H_2$  or to  $H_3$ . For  $q \geq 4$ , there is a vertex  $w \in N_G(x) - \{y, z\}$ . From Claim 4 it follows that there has to be another component  $R$  of  $G'$  with  $\alpha(R) \leq 2$  and structure like in (i) and such that  $|N_G(\{y, w\}, R)| \geq q$ . Since all neighbors of  $y$  are already contained in  $V(Q) \cup \{x\}$ , it follows that  $|N_G(w, R)| = |N_G(\{y, w\}, R)| \geq q$ , which is a contradiction, since  $w$  is adjacent to  $x$  and it has at most  $q$  neighbors in  $G$ . Hence, we may now assume that  $\alpha(Q) = 1$ , that is  $Q \cong K_q$ , and that every vertex of  $Q$  is contained in  $N_G(\{y, z\})$ . If  $q = 3$ , then it is easy to see that  $G \cong H_1$ . Thus, suppose that  $q \geq 4$ . If  $G$  has three pairwise non-adjacent vertices  $w, y, z$  from  $N_G(x)$ , it follows from Claim 4 that each pair of vertices of  $\{w, y, z\}$  has at least  $q$  neighbors contained in a particular component with structure like in (i) and thus we would have  $d_G(w) + d_G(y) + d_G(z) \geq 3q + 3$ , which is a contradiction to the fact that  $q$  is the maximum degree in  $G$ . Therefore, it holds for all vertices  $w \in N_G(x) - \{y, z\}$  that  $w$  is adjacent either to  $y$  or to  $z$  in  $G$  or to both. This implies that

$$\begin{aligned} 2q &\geq d_G(y) + d_G(z) \\ &\geq 2 + |N_G(y) \cap N_G(x)| + |N_G(z) \cap N_G(x)| + |N_G(\{y, z\}, Q)| \\ &\geq 2 + |N_G(x) - \{y, z\}| + |N_G(\{y, z\}, Q)| = 2q - 1. \end{aligned}$$

Hence,  $|N_G(y) \cap N_G(x)| + |N_G(z) \cap N_G(x)| \leq q - 2$ . If  $q = 4$ , it is easy to see that  $y$  and  $z$  are both adjacent to  $w$  and one obtains that  $G \cong H_4$ . If  $q \geq 5$  this implies that there has to be a vertex  $v \in N_G(x) - \{y, z\}$  which is not adjacent to one of the vertices  $y$  or  $z$ , say, without loss of generality, to  $y$ . The inequality above also implies that  $y$  has already  $q - 1$  neighbors in  $V(Q) \cup N_G[x]$ . It follows again with Claim 4 that there is a component  $R$  with structure like in (i) such that  $|N_G(\{v, y\}, R)| \geq q$  and we obtain that  $|N_G(v, R)| = q - 1$  and  $|N_G(y, R)| = 1$ . But this implies that  $v$  is neither

adjacent to  $y$  nor to  $z$ , which is a contradiction.

Hence, for  $q \geq 5$ , only the structure of (i) is possible for  $G$  and the proof of the theorem is complete.  $\square$

**Corollary 3.15** (Hansberg, Meierling, Volkmann [36]) *Let  $G$  be a connected non-regular graph of order  $n$  and maximum degree  $\Delta$ . Then  $\alpha(G) = \frac{n}{\Delta}$  if and only if*

- (i)  $G$  consists of several cliques of order  $\Delta$  connected by a matching, or
- (ii)  $\Delta = 3$  and  $G$  consists of several graphs isomorphic to  $H_1$ , to  $H_2$ , to  $H_3$  (illustrated in Figure 3.1) or to the complete graph  $K_3$ , all of them connected by a matching, or
- (iii)  $\Delta = 4$  and  $G$  consists of several graphs isomorphic to  $H_4$  (illustrated in Figure 3.1) or to the complete graph  $K_4$ , all of them connected by a matching.

If  $G$  is a connected non-complete and regular graph such that properties (i)-(iii) of Corollary 3.15 are satisfied, that is, the matching connecting the different subgraphs is perfect and not empty, then  $\alpha(G) = \frac{n(G)}{\Delta(G)}$  is fulfilled. Also, the graphs illustrated in Figure 3.2 satisfy  $\alpha = \frac{n}{\Delta}$ .

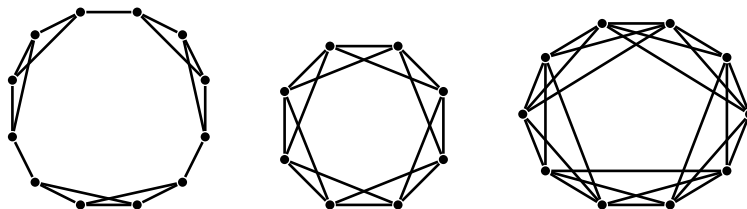

Figure 3.2: A 3-, a 4- and a 5-regular graph with  $\alpha = \frac{n}{\Delta}$ .

We believe that the connected regular graphs with  $\alpha = \frac{n}{\Delta}$  are exactly those non-complete connected regular graphs satisfying properties (i)-(iii) of Corollary 3.15 with exception of a finite number of special cases, to which the graphs of Figure 3.2 belong. We present this statement in the following conjecture.

**Conjecture 3.16** (Hansberg, Meierling, Volkmann [36]) *Let  $G$  be a connected  $\Delta$ -regular graph. Then there is a finite set  $\mathcal{H}$  of regular graphs such*

that  $\alpha(G) = \frac{n(G)}{\Delta}$  if and only if  $G$  is either a non-complete graph satisfying properties (i)-(iii) of Corollary 3.15 or  $G \in \mathcal{H}$ .

However, in order to characterize these graphs, we cannot proceed inductively like in Theorem 3.14 and therefore another method is required.

Now we will discuss which connected graphs fulfill the equality in the bound of Theorem 3.13. These turn to be, with some exceptions, a subclass of the graphs satisfying  $\alpha = n/\Delta$ . As for this class, we achieve the characterization for the non-regular graphs, whereas the regular case depends on our conjecture.

**Theorem 3.17** (Hansberg, Meierling, Volkmann [36]) *Let  $G$  be a connected non-regular graph and  $k$  an integer such that  $k \leq \delta(G)$ . Then*

$$\gamma_k(G) = (\Delta(G) - 1)\alpha(G)$$

*if and only if  $G$  is the  $K_k$ -corona graph of a  $K_2$ .*

**Proof.** If  $G$  is isomorphic to the  $K_k$ -corona graph of a  $K_2$ , it is easy to verify that  $\gamma_k(G) = (\Delta - 1)\alpha(G)$ . Conversely, suppose that  $\gamma_k(G) = (\Delta - 1)\alpha(G)$ . With Corollary 3.10, because of  $\alpha(G) \geq \frac{n}{\chi(G)}$ , we obtain

$$(\Delta - 1)\alpha(G) = \gamma_k(G) \leq \frac{\chi(G) - 1}{\chi(G)}n \leq (\chi(G) - 1)\alpha(G)$$

and thus with Brooks' Theorem, since  $G$  is neither a complete graph nor a cycle, it follows that  $\Delta = \chi(G)$  and hence  $\gamma_k(G) = \frac{\chi(G)-1}{\chi(G)}n = \frac{\Delta-1}{\Delta}n$ . Now Theorem 1.5 and the fact that  $k \leq \delta(G) \leq \Delta - 1$  lead to

$$\frac{\Delta - 1}{\Delta}n = \gamma_k(G) \leq \frac{k}{k+1}n \leq \frac{\Delta - 1}{\Delta}n, \quad (3.1)$$

which implies that  $\gamma_k(G) = \frac{k}{k+1}n$  and  $\Delta - 1 = k$ . With Theorem 2.10 we obtain that  $G$  is isomorphic to the  $K_k$ -corona graph of a connected graph  $J$ . Since the maximum degree of  $G$  is  $\Delta = \delta(G) + 1$ , the graph  $J$  is necessarily isomorphic to the  $K_2$  and we are done.  $\square$

**Theorem 3.18** (Hansberg, Meierling, Volkmann [36]) *Let  $G$  be a connected  $\Delta$ -regular graph and  $k$  a positive integer such that  $\Delta \geq k$ . Then  $\gamma_k(G) = (\Delta - 1)\alpha(G)$  if and only if  $G$  is either isomorphic to the  $K_{k+2}$ , or  $k = 1$  and  $G$  is a cycle of length 4, 5 or 7, or  $k = \Delta$  and  $\alpha(G) = \frac{n(G)}{\Delta}$ .*

**Proof.** Let  $G$  be a  $\Delta$ -regular graph. If  $G \cong K_n$ , then  $\gamma_k(G) = k$ ,  $\alpha(G) = 1$  and  $\Delta(G) = n - 1$  and thus  $\gamma_k(G) = (\Delta - 1)\alpha(G)$  holds exactly when  $n = k + 2$ . If  $G$  is a cycle different from  $C_3 \cong K_3$ , then it is a simple matter to verify that  $\gamma(G) = \alpha(G)$  if and only if it has length 4, 5 or 7. If  $G$  is a cycle of odd length, then it is evident that  $\gamma_2(G) \neq \alpha(G)$ . Assume now that  $G$  is neither complete nor a cycle of odd length nor the cycle  $C_4$ .

Let be  $\Delta = k$  and  $\alpha(G) = \frac{n(G)}{\Delta}$ . We will show that  $\gamma_\Delta(G) = (\Delta - 1)\alpha(G)$  follows. Suppose to the contrary that  $D$  is a  $\Delta$ -dominating set with less vertices than  $(\Delta - 1)\alpha(G)$ . Since for each vertex  $x \in V(G) - D$  all neighbors of  $x$  are contained in  $D$ ,  $V - D$  is an independent set. Hence,  $|V - D| \leq \alpha(G)$  and thus

$$|V| = |V - D| + |D| < \alpha(G) + (\Delta - 1)\alpha(G) = \Delta\alpha(G),$$

which is a contradiction. So, with Theorem 3.13, we obtain  $\gamma_\Delta(G) = (\Delta - 1)\alpha(G)$ .

Conversely, if  $G$  fulfills  $\gamma_k(G) = (\Delta - 1)\alpha(G)$ , we obtain as in Theorem 3.17 that

$$(\Delta - 1)\alpha(G) = \gamma_k(G) \leq \frac{\chi(G) - 1}{\chi(G)}n \leq (\chi(G) - 1)\alpha(G) \leq (\Delta - 1)\alpha(G).$$

This implies that  $\gamma_k(G) = \frac{\Delta-1}{\Delta}n$  and that  $\alpha(G) = \frac{n(G)}{\Delta}$ . Since  $G$  is not a cycle of length 4 and because of the regularity,  $G$  cannot be of the form of the graphs of Theorem 2.10. Therefore, the last inequality in the inequality chain (3.1) cannot occur and it follows that  $k = \delta(G) = \Delta$ .  $\square$

**Remark 3.19** (Hansberg, Meierling, Volkmann [36]) *Let  $G$  be a connected  $\Delta$ -regular graph and  $k$  a positive integer with  $\Delta \geq k$ . If our conjecture is true, then  $\gamma_k(G) = (\Delta - 1)\alpha(G)$  if and only if  $G$  is either isomorphic to the  $K_{k+2}$ , or  $k = 1$  and  $G$  is a cycle of length 4, 5 or 7, or  $k = \Delta$  and  $G$  either satisfies properties (i)-(iii) of Corollary 3.15 or  $G$  is contained in  $\mathcal{H}$ .*

## 3.2 Independence and 2-domination in graphs

In [6], Blidia, Chellali and Favaron examined the relation between the independence number and the 2-domination number in trees. In particular, they proved that the ratio  $\gamma_2(T)/\alpha(T)$  for a tree  $T$  is contained in a small interval.

**Theorem 3.20** (Blidia, Chellali, Favaron [6], 2005) *For any tree,  $\alpha(T) \leq \gamma_2(T) \leq \frac{3}{2}\alpha(T)$ .*

Actually, from Corollary 3.7 it follows directly that the upper bound given in this theorem yet holds for all connected bipartite graphs with at least 3 vertices. Since the proof for the case  $k = 2$  was found earlier and as it is very illuminating, we will present it here again. Moreover, we will give a nice characterization of the equality. But first we need some tools.

**Observation 3.21** (Fujisawa, Hansberg, Kubo, Saito, Sugita, Volkmann [30], 2008) *If a connected graph  $G$  is the corona of a corona graph or the corona of the cycle  $C_4$ , then  $\gamma_2(G) = \frac{3}{2}\alpha(G) = \frac{3}{4}n(G)$ .*

**Observation 3.22** (Fujisawa, Hansberg, Kubo, Saito, Sugita, Volkmann [30], 2008) *If  $G$  is the corona graph of a connected graph  $H$  of order at least two, then  $\gamma_2(G) \leq \frac{3}{4}n(G)$  with equality if and only if  $H$  is either the corona of a connected graph or  $H$  is isomorphic to the cycle  $C_4$ .*

**Proof.** Let  $L$  be the set of leaves of  $G$  and let  $D$  be a minimum dominating set of  $H = G - L$ . Then, since  $G$  is a corona graph,  $D \cup L$  is a minimum 2-dominating set of  $G$  and hence we obtain with Ore's inequality

$$\gamma_2(G) = \gamma(H) + |L| \leq \frac{|G - L|}{2} + |L| = \frac{3}{4}n(G).$$

In view of Theorem 1.2, equality holds if and only if  $H$  is the corona of a connected graph or if  $H \cong C_4$ .  $\square$

**Theorem 3.23** (Fujisawa, Hansberg, Kubo, Saito, Sugita, Volkmann [30], 2008) *If  $G$  is a connected bipartite graph of order at least 3, then  $\gamma_2(G) \leq \frac{3}{2}\alpha(G)$  and equality holds if and only if  $G$  is the corona of the corona of a connected bipartite graph or  $G$  is the corona of the cycle  $C_4$ .*

**Proof.** Let  $L$  be the set of leaves in  $G$ , and let  $I$  be a maximum independent set of  $G$ . Since  $n(G) \geq 3$ , we can assume, without loss of generality, that  $L \subseteq I$  and thus it follows that  $|L| \leq \alpha(G)$ . Since  $G$  is bipartite, evidently  $2\alpha(G) \geq n(G)$ .

Let  $A$  and  $B$  be the partition sets of  $G$ . Define  $A_1 := A - L$  and  $B_1 := B - L$  and assume, without loss of generality, that  $|A_1| \leq |B_1|$ . Then  $|A_1| \leq \frac{n(G) - |L|}{2}$ . Since every vertex in  $B_1$  has at least two neighbors in  $A_1 \cup L$ , we see that the latter is a 2-dominating set of  $G$  and hence

$$\gamma_2(G) \leq |A_1 \cup L| \leq \frac{n(G) - |L|}{2} + |L| = \frac{n(G) + |L|}{2}.$$

Combining this inequality with  $|L| \leq \alpha(G)$  and  $n(G) \leq 2\alpha(G)$ , we obtain the desired bound

$$\gamma_2(G) \leq \frac{n(G) + |L|}{2} \leq \frac{2\alpha(G) + \alpha(G)}{2} = \frac{3}{2}\alpha(G).$$

Thus  $G$  is a bipartite graph with  $\gamma_2(G) = \frac{3}{2}\alpha(G)$  if and only if  $n(G) = 2\alpha(G)$ ,  $|L| = \alpha(G)$  and  $\gamma_2(G) = \frac{n(G)+|L|}{2}$ . The facts that  $|L| = \alpha(G)$  and  $n(G) = 2\alpha(G) = 2|L|$  show that  $G$  is a corona graph. Furthermore, the identity  $\gamma_2(G) = \frac{n(G)+|L|}{2}$  leads to  $\gamma_2(G) = \frac{3}{4}n(G)$  and, in view of Observation 3.22, it follows that  $G$  is either the corona of the corona of a connected bipartite graph or  $G$  is the corona of the cycle  $C_4$ .

Conversely, if  $G$  is either the corona of the corona of a bipartite graph or  $G$  is the corona of the cycle  $C_4$ , then Observation 3.21 implies that  $\gamma_2(G) = \frac{3}{2}\alpha(G)$ .  $\square$

In 1998, Randerath and Volkmann and independently, in 2000, Xu, Cockayne, Haynes, Hedetniemi and Zhou characterized the odd order graphs  $G$  for which  $\gamma(G) = \lfloor n(G)/2 \rfloor$ . In the next theorem, we only note the part of this characterization which we will use for the next theorem.

**Theorem 3.24** (Randerath, Volkmann [60], 1998; Xu, Cockayne, Haynes, Hedetniemi, Zhou [21], 2000) *Let  $G$  be a nontrivial connected bipartite graph of odd order. Then  $\gamma(G) = \lfloor n(G)/2 \rfloor$  if and only if*

- (i)  $G$  consists of two cycles with a common vertex, or
- (ii)  $G$  is isomorphic to the complete graph  $K_{2,3}$ , or
- (iii)  $|N_G(L(G))| = |L(G)| - 1$  and  $G - N_G[L(G)] = \emptyset$ , or
- (iv)  $|N_G(L(G))| = |L(G)|$  and  $G - N_G[L(G)]$  is an isolated vertex, or
- (v)  $|N_G(L(G))| = |L(G)|$  and  $G - N_G[L(G)]$  is a star of order three such that the center of the star has degree two in  $G$ , or
- (vi)  $|N_G(L(G))| = |L(G)|$  and  $G - N_G[L(G)]$  is a bipartite graph  $G_1$  with  $|G_1| = 5$ ,  $\gamma(G_1) - \delta(G_1) = 2$ , and the graph  $G'_1$ , induced by the vertices of  $G_1$ , which are not adjacent to a vertex of  $N(L(G), G)$ , is a  $C_4$ , or
- (vii)  $|N_G(L(G))| = |L(G)|$  and  $G - N_G[L(G)]$  is a bipartite graph  $H_1$  with one leaf  $u$ , which is also a cut vertex of  $G$ , and  $H_1 - u = C_4$ .

Next, we present the characterization of the bipartite graphs  $G$  of odd order with  $\gamma_2(G) = \frac{3\alpha(G)-1}{2}$ .

**Theorem 3.25** *Let  $G$  be a connected bipartite graph of order at least 3 such that  $\alpha = \alpha(G)$  is odd. Then  $\gamma_2(G) = \frac{3\alpha(G)-1}{2}$  if and only if*

- (a)  $G \cong K_1 \circ (K_1 \circ J) + \{x, xy\}$ , where  $y \in V(J)$  and  $x$  is a new vertex.
- (b)  $G \cong K_1 \circ H$ , where  $H$  is a member of the family described in Theorem 3.24.
- (c)  $G \cong K_1 \circ H - \{a, b\}$ , where  $a$  and  $b$  are leaves of  $K_1 \circ H$  with adjacent support vertices  $u$  and  $v$  such that  $d_H(u), d_H(v) \geq 2$  and either:
  - (i)  $H \cong K_1 \circ J$ , where  $J$  is a connected bipartite graph with  $u, v \in V(J)$ ,
  - (ii)  $H \cong C_4$ ,
  - (iii)  $H \cong (K_1 \circ J) + \{uv\}$ , where  $J$  is a bipartite graph and  $u, v \in L(K_1 \circ J)$ ,
  - (iv)  $H \cong (K_1 \circ J) + \{x, y, uv, xu', yv', xy\}$ , where  $J$  is a bipartite graph  $u, v \in L(K_1 \circ J)$ ,  $l_{K_1 \circ J}(u') = u$ ,  $l_{K_1 \circ J}(v') = v$  and  $x$  and  $y$  are new vertices,
  - (v)  $H \cong K_1 \circ J - \{l_{K_1 \circ J}(u), l_{K_1 \circ J}(v)\}$ , where  $J$  is a bipartite graph with  $u, v \in V(J)$  and where  $d_H(u) = 2$ ,
  - (vi)  $H \cong (K_1 \circ J) + \{l_{K_1 \circ J}(u)x\}$ , where  $J$  is a connected bipartite graph with  $u, v \in V(J)$  and  $x$  is a vertex in  $L(K_1 \circ J) \cap N_{K_1 \circ J}(N_{K_1 \circ J}(u) - \{v\})$ , or
  - (vii)  $H \cong (K_1 \circ J) + \{l_{K_1 \circ J}(u)x, l_{K_1 \circ J}(v)y\}$ , where  $J$  is a connected bipartite graph with  $u, v \in V(J)$ ,  $x \in L(K_1 \circ J) \cap N_{K_1 \circ J}(N_{K_1 \circ J}(u) - \{v\})$  and  $y \in L(K_1 \circ J) \cap N_{K_1 \circ J}(N_{K_1 \circ J}(v) - \{u\})$ .

**Proof.** Let  $L = L(G)$ . According to the proof of Theorem 3.23, we have

$$\gamma_2(G) \leq \frac{n(G) + |L|}{2} \leq \frac{3\alpha}{2}. \quad (3.2)$$

Since  $G$  is a bipartite graph of order at least 3, we observe that  $n(G) \leq 2\alpha$  and  $|L| \leq \alpha$ . Combining this with (3.2), the hypothesis  $\gamma_2(G) = (3\alpha - 1)/2$  implies that either  $n(G) = 2\alpha - 1$  and  $|L| = \alpha$ ,  $n(G) = 2\alpha$  and  $|L| = \alpha - 1$  or  $n(G) = 2\alpha$  and  $|L| = \alpha$ .

(a) Assume that  $n(G) = 2\alpha - 1$  and  $|L| = \alpha$ . If  $\gamma_2(G) = (3\alpha - 1)/2$ , then  $\gamma_2(G) = (3n(G) + 1)/4$  and thus  $n(G) = 4q + 1$  and  $\gamma_2(G) = 3q + 1$  for an integer  $q \geq 1$ . Because of  $|L| = \alpha$  and  $n(G) = 2\alpha - 1$ , it follows that each vertex  $x \in V(G) - L$  is adjacent to at least one leaf and exactly one

vertex of  $V(G) - L$  is adjacent to two leaves of  $G$ . If  $H = G - L$ , then  $H$  is a connected bipartite graph of order  $2q$ . If  $D$  is a  $\gamma(H)$ -set, then  $D \cup L$  is a 2-dominating set of  $G$ . Therefore Theorem 1.1 implies that

$$3q + 1 = \gamma_2(G) \leq |L| + |D| \leq |L| + \frac{n(H)}{2} = |L| + \frac{|G - L|}{2} = 3q + 1$$

and so  $\gamma(H) = |D| = n(H)/2$ . In view of Theorem 1.2, the graph  $H$  is a corona graph of a connected bipartite graph or  $H$  is isomorphic to the cycle  $C_4$  of length four.

If  $H = C_4$ , then  $G$  has not the desired properties. Now let  $H$  be a corona graph with  $L(H) = \{u_1, u_2, \dots, u_q\}$  and  $V(H) - L(H) = \{v_1, v_2, \dots, v_q\}$  such that  $u_i$  is adjacent to  $v_i$  for  $1 \leq i \leq q$ . If, say,  $u_q$ , is adjacent to two leaves of  $G$ , then we arrive at the contradiction

$$3q + 1 = \gamma_2(G) \leq |L| + |\{v_1, v_2, \dots, v_{q-1}\}| = 3q.$$

In the remaining case that  $v_i$  is adjacent to two leaves of  $G$ , we obtain the desired result  $\gamma_2(G) = 3q + 1$  and  $G$  has the form of (a).

(b) Assume that  $n(G) = 2\alpha$  and  $|L| = \alpha$ . If  $\gamma_2(G) = (3\alpha - 1)/2$ , then  $\gamma_2(G) = (3n(G) - 2)/4$  and thus  $n(G) = 4q + 2$  and  $\gamma_2(G) = 3q + 1$  for an integer  $q \geq 1$ . Because of  $|L| = \alpha$  and  $n(G) = 2\alpha$ , it follows that each vertex  $x \in V(G) - L$  is adjacent to exactly one leaf of  $G$ , and hence  $G$  is a corona graph of connected bipartite graph  $H$  of order  $n(H) = 2q + 1$ . If  $D$  is a  $\gamma(H)$ -set, then  $D \cup L$  is a 2-dominating set of  $G$ . Therefore Theorem 1.1 implies that

$$3q + 1 = \gamma_2(G) \leq |L| + |D| \leq |L| \leq \left\lfloor \alpha + \frac{n(H)}{2} \right\rfloor = 3q + 1$$

and so  $\gamma(H) = |D| = (n(H) - 1)/2$ . Thus the graph  $H$  is a member of the family described in Theorem 3.24 (i) - (vii). Conversely, if  $H$  is a member of the family described in Theorem 3.24 (i) - (vii)i, then it is straightforward to verify that  $G$  has the desired properties.

(c) Assume that  $n(G) = 2\alpha$  and  $|L| = \alpha - 1$ . If  $\gamma_2(G) = 3(\alpha - 1)/2$ , then  $\gamma_2(G) = (3n(G) - 2)/4$  and thus  $n(G) = 4q + 2$ ,  $\gamma_2(G) = 3q + 1$ ,  $\alpha = 2q + 1$  and  $|L| = 2q$  for an integer  $q \geq 1$ .

First we show that no vertex of  $H = G - L$  is adjacent to two ore more leaves of  $G$ . Suppose to the contrary that  $u \in V(G) - L$  is adjacent to  $r \geq 2$  leaves. If  $R \subset V(G) - L$  is the set of vertices not adjacent to any leaf, then  $|L| = \alpha - 1 = 2q$  implies that  $|R| \geq 3$ . Thus  $\alpha = 2q + 1$  implies that  $G[R]$  is a complete graph, a contradiction to the hypothesis that  $G$  is a bipartite graph.

Now let  $u, v \in V(G) - L$  be exactly the two vertices, which are not adjacent to a leaf of  $G$ . Since  $\alpha = |L| + 1$ , we observe that  $u$  and  $v$  are adjacent and  $d_H(u), d_H(v) \geq 2$ . Since  $H$  is a connected bipartite graph of order  $n(H) = 2q + 2$ , Theorem 1.1 implies that  $\gamma(H) \leq q + 1$ . If  $\gamma(H) \leq q - 1$ , then we easily obtain the contradiction

$$3q + 1 = \gamma_2(G) \leq |L| + q = 3q.$$

Assume that  $\gamma(H) = q + 1 = n(H)/2$ . According to Theorem 3.24, the graph  $H$  is a corona graph of a connected bipartite graph  $J$  or  $H$  is isomorphic to the cycle  $C_4$  of length four. Because of  $d_H(u), d_H(v) \geq 2$ , if  $H \cong K_1 \circ J$ , we deduce that  $u, v \in V(J)$ . Hence,  $G$  is of the form of (c)(i) or (c)(ii). Conversely, if  $H$  is like in (c)(i) or (c)(ii), then  $G$  has the desired properties.

Finally, assume that  $\gamma(H) = q = (n(H) - 2)/2$ . Let  $\hat{H} = H - N_H[\{u, v\}]$ , let  $I$  be the set of isolated vertices in  $\hat{H}$  and  $Q = \hat{H} - I$ . Define  $I_u = I \cap N_H(N_H(u))$  and  $I_v = I \cap N_H(N_H(v))$  and let  $D$  be a minimum dominating set of the graph  $Q$ . Since  $G$  is bipartite and  $uv \in E(G)$ , it is clear that  $I_u \cap I_v = \emptyset$ . Since  $H$  is connected, each component of  $\hat{H}$  has vertices adjacent to some vertex in  $N = N(\{u, v\}) - \{u, v\}$ , in particular, the vertices from  $I$  have all at least one neighbor in the latter. Now we distinguish three cases.

*Case 1.* Assume that  $I = \emptyset$ . Then  $\hat{H} = Q$  and  $L \cup D \cup \{u, v\}$  is a 2-dominating set of  $G$  and thus, with Theorem 1.1, we obtain

$$3q + 1 = \gamma_2(G) \leq |L| + |D| + 2 \leq 2q + \frac{n(Q)}{2} + 2 = 2q + \frac{n(H)}{2} = 3q + 1,$$

which implies that  $\gamma(Q) = n(Q)/2$  and  $|N_H[\{u, v\}]| = 4$ . Hence, since  $Q$  has no isolated vertices, according to Theorems 1.1 and 1.2, each component of  $Q$  is a corona graph or a cycle of length four. Let  $\{u'\} = N_H(v) - \{v\}$  and  $\{v'\} = N_H(u) - \{u\}$ . Suppose that there is a component  $C$  of  $Q$  which is a  $C_4$ , say  $C = x_1x_2x_3x_4x_1$ . Since  $G$  is connected, one of the vertices  $x_i$  has a neighbor in  $\{u', v'\}$ . Without loss of generality, say that  $x_1v' \in E(G)$ . Then, if  $D'$  is a minimum dominating set of  $Q - C$ ,  $L \cup D' \cup \{u, v', x_3\}$  is a 2-dominating set of  $G$  with at most  $2q + n(Q - C)/2 + 3 = 3q$  vertices, a contradiction. Therefore, every component of  $Q$  is a corona graph, that is,  $Q \cong K_1 \circ J'$  for a bipartite graph  $J'$ . Now we will determine which vertices of  $Q$  can be adjacent to  $u'$  or to  $v'$ . If  $u'$  and  $v'$  have only neighbors in  $V(J')$ , then  $G$  is of the form of (c)(iii) with  $J = J'$ . Thus, suppose first that  $u'$  ( $v'$ ) is neighbor of a leaf  $z$  of a component  $C$  of  $Q$  with  $n(C) \geq 4$ . Then, if  $z'$  is the support vertex of  $z$  in  $Q$ ,  $L \cup (V(J') - \{z'\}) \cup \{u', v\}$  ( $L \cup (V(J') - \{z'\}) \cup \{v', u\}$ ) is a 2-dominating set of  $G$  with  $3q$  vertices, which is a contradiction. Suppose

now that there are two trivial components  $C_1$  and  $C_2$  of  $J'$  with  $V(C_i) = \{x_i\}$  for  $i = 1, 2$  and such that  $u'$  is neighbor of  $x_1$  and  $x_2$  and  $v'$  is neighbor of  $l_Q(x_1)$  and of  $l_Q(x_2)$  in  $G$ . Then the set  $L \cup (V(J') - \{x_1, x_2\}) \cup \{u, u', v'\}$  is a 2-dominating set of  $G$  with  $3q$  vertices, which is not possible. Hence, there is at most one trivial component  $C$  of  $J'$  such that, if  $V(C) = \{x\}$ ,  $u'$  is neighbor of  $x$  and  $v'$  is neighbor of  $y = l_Q(x)$ . In this case we obtain that  $G$  has the structure like in (c)(iv) with  $J = H[V(J') \cup \{u', v'\}]$ .

*Case 2. Assume that  $I \neq \emptyset$ .*

*Subcase 2.1. Suppose that  $|N| < |I|$ .* Then  $L \cup N \cup \{v\} \cup D$  is a 2-dominating set of  $G$  and thus

$$\begin{aligned} 3q + 1 = \gamma_2(G) &\leq |L| + |N \cup \{v\}| + |D| \\ &< 2q + \frac{|N \cup \{u, v\} \cup I|}{2} + \frac{n(Q)}{2} \\ &= 2q + \frac{n(H)}{2} = 3q + 1, \end{aligned}$$

which is a contradiction.

*Subcase 2.2. Suppose that  $|N| = |I|$ .* Assume first that both  $d_G(u)$  and  $d_G(v)$  are at least 3. Then  $L \cup N \cup D$  is a 2-dominating set of  $G$  with at most

$$2q + \frac{|N \cup I|}{2} + \frac{n(Q)}{2} = 2q + \frac{n(H) - 2}{2} = 3q$$

vertices, which contradicts the hypothesis taken for this case. Thus, assume, without loss of generality, that  $d_G(u) = 2$ . Now the set  $L \cup N \cup \{v\} \cup D$  is a 2-dominating set of  $G$  and thus

$$\begin{aligned} 3q + 1 = \gamma_2(G) &\leq |L| + |N \cup \{v\}| + |D| \\ &\leq 2q + \frac{|N \cup \{u, v\} \cup I|}{2} + \frac{n(Q)}{2} \\ &= 2q + \frac{n(H)}{2} = 3q + 1, \end{aligned}$$

which implies that  $\gamma(Q) = n(Q)/2$ . Again, the components of  $Q$  have to be either corona graphs or cycles of length 4. As in Case 1, the possibilities that a component of  $Q$  is a cycle of length 4 and that a vertex from  $N$  is adjacent to a leaf of a corona component  $C$  of  $Q$  with  $n(C) \geq 4$  can be eliminated analogously. Hence, we can regard  $Q$  as the corona of a (not necessarily connected) bipartite graph  $J'$ . Now suppose that there is a component  $C$  of  $Q$  with  $V(C) = \{x, y\}$  and that there are vertices  $u' \in N_G(u) - \{v\} = N \cap N_G(u)$  and  $v' \in N_G(v) - \{u\} = N \cap N_G(v)$  such that  $u'$  is adjacent to  $x$  and  $v'$  is adjacent to  $y$ . Then the set  $L \cup N \cup (V(J') - \{x\})$  is a 2-dominating set of  $G$

with  $3q$  vertices and we have a contradiction. Thus we can say, without loss of generality, that the vertices of  $N$  have only neighbors from  $V(J') \cup I$  and hence if  $J = J' + I$ , then  $H$  is the corona of the graph  $J$  without the leaves whose support vertices are  $u$ , and  $v$ , i. e.  $H$  is like in (c)(v).

*Subcase 2.3.* Suppose that  $|N| = |I| + 1$ . Then there is a vertex  $x \in I$  such that  $|N(x) \cap N| \geq 2$ . If  $y$  is a vertex from  $N(x) \cap N$ , then  $L \cup (N - \{y\}) \cup \{u\} \cup D$  is a 2-dominating set of  $G$  and thus

$$\begin{aligned} 3q + 1 = \gamma_2(G) &\leq |L| + |N - \{y\}| + 1 + |D| \\ &\leq 2q + \frac{|N \cup I| - 1}{2} + 1 + \frac{n(Q)}{2} \\ &= 2q + \frac{n(H) - 1}{2} = 3q + \frac{1}{2}, \end{aligned}$$

which implies that this case is not possible.

*Subcase 2.4.* Suppose that  $|N| = |I| + 2$ . Assume first that  $|N - N_H(I)| = 2$ . Then we have  $|N_H(I)| = |I|$ . If there were vertices  $u' \in N_G(u)$  and  $v' \in N_G(v)$  such that  $N = N_H(I) \cup \{u', v'\}$ , then  $N_H(I) \cup \{u, v\} \cup D$  would be a dominating set of  $H$  with at most  $\frac{n(H)}{2}$  vertices, a contradiction to the assumption that  $\gamma(H) = q$ . Hence, we may assume that  $N - N_H(I) \subseteq N_G(u)$  and thus  $L \cup N_H(I) \cup \{u\} \cup D$  is a 2-dominating set of  $G$  and therefore we obtain following contradiction:

$$\begin{aligned} 3q + 1 = \gamma_2(G) &\leq |L| + |N_H(I)| + 1 + |D| \\ &\leq 2q + \frac{|N_H(I) \cup I|}{2} + 1 + \frac{n(Q)}{2} \\ &= 2q + \frac{n(H) - 2}{2} = 3q. \end{aligned}$$

It follows that  $|N - N_H(I)| \leq 1$ . Let  $S$  be a subset of  $N_H(I)$  with  $|S| = |I|$  such that every vertex in  $I$  has a neighbor in  $S$ . Then  $L \cup S \cup \{u, v\} \cup D$  is a 2-dominating set of  $G$  and we obtain

$$\begin{aligned} 3q + 1 = \gamma_2(G) &\leq |L| + |S| + 2 + |D| \\ &\leq 2q + \frac{|S \cup I|}{2} + 2 + \frac{n(Q)}{2} \\ &= 2q + \frac{n(H)}{2} = 3q + 1. \end{aligned}$$

Therefore, we have again that  $\gamma(Q) = n(Q)/2$  and thus the components of  $Q$  are either corona graphs or cycles of length 4. Similarly as in the former cases, we obtain contradictions for the cases that either a component of  $Q$  is

a cycle of length 4 and that a vertex from  $N_G(\{u, v\}) - \{u, v\}$  is adjacent to a leaf of a corona component  $C$  of  $Q$  with  $n(C) \geq 4$ . Also as in Case 2, it is not possible that two vertices from  $N_G(\{u, v\}) - \{u, v\}$  are adjacent each of them to a vertex of a component  $C$  of  $Q$  with  $n(C) = 2$ . With similar arguments as before and using the fact that  $G$  does not contain cycles of odd length, it is straight forward to verify that there can only be added either an edge joining  $u'$  and a vertex in  $N_G(u) - \{v\}$  or rather an edge joining  $v'$  and a vertex in  $N_G(v) - \{u\}$  or both. It follows that  $H$  is the corona of a graph  $J = J'$  together with one or two of the edges mentioned here. These are exactly the graphs described in (c)(vi) and (c)(vii).

*Subcase 2.5.* Suppose that  $|N| > |I| + 2$ . Let  $S$  be a subset of  $N_H(I)$  with  $|S| = |I|$  and such that every vertex from  $I$  has a neighbor in  $S$ . Then  $L \cup S \cup \{u, v\} \cup D$  is a 2-dominating set of  $G$  and, since  $|N - S| \geq 3$ , we obtain the contradiction

$$\begin{aligned} 3q + 1 = \gamma_2(G) &\leq |L| + |S| + 2 + |D| \\ &\leq 2q + \frac{|N \cup I| - 3}{2} + 2 + \frac{n(Q)}{2} \\ &= 2q + \frac{n(H) - 1}{2} = 3q + \frac{1}{2}. \end{aligned}$$

Hence, this case cannot occur.

Conversely, if  $G$  has structure like in (c)(i) - (vii), it is straight forward to verify that  $\gamma_2(G) = \frac{3\alpha(G)-1}{2}$ . □

### 3.3 Independent domination and 2-domination

If a dominating set  $D$  of a graph  $G$  is also independent, then  $D$  is called an *independent dominating set*. The cardinality of a minimum independent dominating set in  $G$  is denoted with  $i(G)$  and is called *independent domination number* of  $G$ . In this section, we will explore the connection between the 2-domination and the independent domination in block-cactus graphs and, more specialized, in trees. Since every independent dominating set is dominating, the inequality  $i(G) \geq \gamma(G)$  is trivial for any graph  $G$ .

**Theorem 3.26** (Hansberg, Volkmann [42]) *If  $G$  is a connected block-cactus graph, then  $\gamma_2(G) \geq i(G)$ .*

**Proof.** If  $G$  is a complete graph or a cycle, then it is easy to see that  $\gamma_2(G) \geq i(G)$ . Now suppose that  $G$  has a cut vertex. We will prove the statement by induction on the number of blocks in  $G$ . Let  $B$  be an end block of  $G$  with cut vertex  $u$  in  $G$ .

*Case 1.* Suppose that  $B \cong K_2$ . Let  $D$  be a  $\gamma_2(G)$ -set and let  $V(B) = \{u, v\}$ .

*Case 1.1.* Suppose that  $u \notin D$ . If  $L_u \cup \{u\} = V(G)$ , then  $G$  is a star and we are done. Let  $|L_u \cup \{u\}| < n$ . Then  $D - L_u$  is a 2-dominating set of  $G' := G - (L_u \cup \{u\})$  and so  $\gamma_2(G') \leq \gamma_2(G) - |L_u|$ . Clearly,  $i(G) \leq i(G') + |L_u|$ . By the induction hypothesis follows  $\gamma_2 \geq i$  for every component of  $G'$  and thus  $\gamma_2(G') \geq i(G')$ . This implies

$$\gamma_2(G) \geq \gamma_2(G') + |L_u| \geq i(G') + |L_u| \geq i(G).$$

*Case 1.2.* Suppose that  $u \in D$ . Since  $D - \{v\}$  is a 2-dominating set of  $G'' := G - v$ , we conclude  $\gamma_2(G'') \leq \gamma_2(G) - 1$ . Since  $i(G) \leq i(G'') + 1$ , we obtain by the induction hypothesis

$$\gamma_2(G) \geq \gamma_2(G'') + 1 \geq i(G'') + 1 \geq i(G).$$

*Case 2.* Assume that  $B \cong K_p$  for an integer  $p \geq 3$ . Let  $D$  be a  $\gamma_2(G)$ -set. Without loss of generality, we can suppose that  $u \in D$ . Then  $D - (V(B) - \{u\})$  is a 2-dominating set of  $G' := G - (V(B) - \{u\})$  and thus together with the induction hypothesis and the evident fact that  $i(G') + 1 \geq i(G)$  we obtain

$$\gamma_2(G) \geq \gamma_2(G') + 1 \geq i(G') + 1 \geq i(G)$$

*Case 3.* Assume that  $B$  is isomorphic to a cycle of length  $p \geq 3$ . Let  $D$  be a  $\gamma_2(G)$ -set. Without loss of generality, we can suppose that  $u \in D$ . Then  $D - (V(B) - \{u\})$  is a 2-dominating set of  $G' := G - (V(B) - \{u\})$  and so

$$\gamma_2(G') \leq \gamma_2(G) - \left\lceil \frac{n(B) - 2}{2} \right\rceil.$$

On the other hand, we observe that

$$i(G) \leq i(G') + \left\lceil \frac{n(B) - 1}{3} \right\rceil.$$

It follows by the induction hypothesis

$$\gamma_2(G) \geq \gamma_2(G') + \left\lceil \frac{n(B) - 2}{2} \right\rceil \geq i(G') + \left\lceil \frac{n(B) - 1}{3} \right\rceil \geq i(G)$$

and the statement is proved.  $\square$

If the block-cactus graph contains a block different from a  $C_4$ , then we can give a better inequality.

**Theorem 3.27** (Hansberg, Volkmann [42]) *Let  $G$  be a connected block-cactus graph. If there is a block  $B$  of  $G$ , which is different from the cycle  $C_4$ , then  $\gamma_2(G) \geq i(G) + 1$ .*

**Proof.** If  $G$  is a complete graph or a cycle different from  $C_4$ , then it is evident that  $\gamma_2(G) \geq i(G) + 1$ . Now suppose that  $G$  has a cut vertex. Let  $B$  be an end block of  $G$  with cut vertex  $u$  in  $G$  such that  $G' := G - (V(B) - \{u\})$  has still a block different from the cycle  $C_4$ . Now we can proceed as in the proof of Theorem 3.1 with the only difference that by the induction hypothesis we have  $\gamma_2(G') \geq i(G') + 1$ . Thus in all three cases we obtain  $\gamma_2(G) \geq i(G) + 1$  and the proof is complete.  $\square$

**Corollary 3.28** (Hansberg, Volkmann [42]) *Let  $G$  be a non-trivial block graph. Then  $\gamma_2(G) \geq i(G) + 1$ .*

**Corollary 3.29** (Hansberg, Volkmann [42]) *Let  $G$  be a unicyclic graph. If  $G \neq C_4$ , then  $\gamma_2(G) \geq i(G) + 1$ .*

Theorem 3.27 allows us to give a former result of Hansberg and Volkmann as a corollary.

**Corollary 3.30** (Hansberg, Volkmann [37, 38]) *If  $G$  is a non-trivial block graph or a unicyclic graph different from the cycle  $C_4$ , then  $\gamma_2(G) \geq \gamma(G) + 1$ .*

**Proof.** In view of the inequality  $\gamma(G) \leq i(G)$  and Corollaries 3.28 and 3.29, the statement is evident.  $\square$

In [37, 38], Hansberg and Volkmann characterized all block graphs and unicyclic graphs  $G$  with  $\gamma_2(G) = \gamma(G) + 1$ .

Additionally, we obtain directly from Theorem 3.27 the following result, which will be very useful for characterizing all block-cactus graphs  $G$  with  $\gamma_2(G) = i(G)$ .

**Corollary 3.31** (Hansberg, Volkmann [42]) *If  $G$  is a block-cactus graph with  $\gamma_2(G) = i(G)$ , then  $G$  only consists of  $C_4$ -blocks.*

Theorem 1.4 of Fink and Jacobson [28] states that, for a graph  $G$  with  $n$  vertices and  $m$  edges,  $\gamma_k(G) \geq n - \frac{m}{k}$  for each  $k \geq 1$  and that the  $k$ -semiregular graphs are exactly the graphs satisfying equality in this bound. For a tree  $T$ , since  $m(T) = n(T) - 1$ , the following theorem is straightforward.

**Theorem 3.32** (Fink, Jacobson [28], 1985) *Let  $k \geq 1$  be an integer. If  $T$  is a tree, then*

$$\gamma_k(T) \geq \frac{(k-1)n(T) + 1}{k}$$

and  $\gamma_k(T) = ((k-1)n(T) + 1)/k$  if and only if  $T$  is a  $k$ -semiregular tree or  $n(T) = 1$ .

Thus, for  $k = 2$ , this implies the next corollary.

**Corollary 3.33** (Fink, Jacobson [28], 1985) *If  $T$  is a tree, then*

$$\gamma_2(T) \geq \frac{n(T) + 1}{2}$$

and  $\gamma_2(T) = \frac{n(T)+1}{2}$  if and only if  $T$  is the subdivision graph of another tree.

In 2007, Volkmann completed the characterization of Theorem 3.32 for the trees  $T$  with  $\gamma_k(T) = \left\lceil \frac{(k-1)n+1}{k} \right\rceil$ .

**Theorem 3.34** (Volkmann [69], 2007) *If  $T$  is a tree of order  $n = n(T)$ , then  $\gamma_k(T) = \left\lceil \frac{(k-1)n+1}{k} \right\rceil$  if and only if*

- (i)  $n = kt + 1$  for an integer  $t \geq 0$  and  $T$  is a  $k$ -semiregular tree or  $n = 1$  or
- (ii)  $n = kt + r$  for integers  $t \geq 0$  and  $2 \leq r \leq k$  and  $T$  consists of  $r$  trees  $T_1, T_2, \dots, T_r$  which satisfy the conditions in (i) and  $r - 1$  further edges such that the trees  $T_1, T_2, \dots, T_r$  together with these  $r - 1$  edges result in a tree.

The following corollary is immediate.

**Corollary 3.35** (Volkmann [69], 2007) *If  $T$  is a tree of order  $n = n(T)$ , then  $\gamma_2(T) = \left\lceil \frac{n+1}{2} \right\rceil$  if and only if*

- (i)  $n$  is odd and  $T$  is the subdivision graph of another tree or

(ii)  $n$  is even and  $T$  consists of two subdivision trees  $S(T_1)$  and  $S(T_2)$  and a further edge, connecting  $S(T_1)$  with  $S(T_2)$ .

**Lemma 3.36** (Hansberg, Volkmann [42]) *Let  $T$  be a tree of order  $n = n(T)$ . If  $\gamma_2(T) = i(T) + 1$ , then  $\gamma_2(T) = \lceil \frac{n+1}{2} \rceil$ .*

**Proof.** Suppose that  $\gamma_2(T) \geq \lceil \frac{n+1}{2} \rceil + 1$ . Let  $A$  and  $B$  be bipartition sets of  $T$ . Then both sets  $A$  and  $B$  are independent and dominating and hence  $i(T) \leq n/2$  holds. It follows

$$\gamma_2(T) \geq \left\lceil \frac{n+1}{2} \right\rceil + 1 > \frac{n}{2} + 1 \geq i(T) + 1,$$

which is a contradiction to our hypothesis. Therefore  $\gamma_2(T) \leq \lceil \frac{n+1}{2} \rceil$  and, together with Corollary 3.33, we obtain  $\gamma_2(T) = \lceil \frac{n+1}{2} \rceil$ .  $\square$

We will use these results for the next theorem.

**Theorem 3.37** (Hansberg, Volkmann [42]) *Let  $T$  be a non-trivial tree of order  $n$ . Then  $\gamma_2(T) = i(T) + 1$  if and only if  $\gamma_2(T) = \gamma(T) + 1$  or  $T$  is isomorphic to the graph  $J$  illustrated in Figure 3.3.*

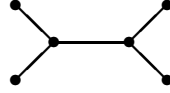

Figure 3.3: Graph  $J$ .

**Proof.** If  $T$  is isomorphic to the graph in Figure 2, then  $\gamma_2(T) = 4 = i(T) + 1$ . If  $\gamma_2(T) = \gamma(T) + 1$ , then, since the inequality  $i(T) \geq \gamma(T)$  is always valid and since  $\gamma_2(T) \geq i(T) + 1$  in view of Corollary 3.28, we obtain  $\gamma_2(T) = i(T) + 1$ .

Conversely, assume that  $\gamma_2(T) = i(T) + 1$ . Hence, Lemma 3.36 leads to  $\gamma_2(T) = \lceil \frac{n+1}{2} \rceil$ . We distinguish two cases.

*Case 1.* Assume that  $n$  is odd. Then  $\gamma_2(T) = (n + 1)/2$  and by Corollary 3.35 it follows that  $T$  is the subdivision graph of another tree. If  $dm(T) \leq 6$ , we obtain that  $T$  is either a subdivided star  $SS_t$  or a subdivided double star  $SS_{s,t}$ , for which  $\gamma_2(T) = \gamma(T) + 1$  hold. We will now prove by induction on  $n$  that we can never reach equality in  $\gamma_2(T) \geq i(T) + 1$  for  $dm(T) \geq 8$ . Let  $z$  be the central vertex of  $T$  and let  $L_i$  be the set of leaves in  $T$  of distance  $i$  from

$z$ . If  $dm(T) = 8$ , then  $N_T(L_4) \cup L_2 \cup \{z\}$  is an independent dominating set of  $G$ . Since  $|L_4| \geq 2$ , one can easily see that  $|N_T(L_4) \cup L_2 \cup \{z\}| \leq \frac{n-3}{2}$  and hence  $\gamma_2(T) = \frac{n+1}{2} > \frac{n-3}{2} + 1 \geq i(T) + 1$ . Now suppose that  $dm(T) \geq 10$ . Let  $u$  be a leaf of  $T$  and  $v$  its support vertex, for which obviously  $d_T(v) = 2$  is fulfilled. Let  $T' := T - \{u, v\}$  and let  $I'$  be an  $i(T')$ -set. Then  $I' \cup \{u\}$  is an independent dominating set of  $T$  and  $i(T) \leq i(T') + 1$  follows. Since  $T'$  is again a subdivision graph and  $dm(T') \geq 8$ , by the induction hypothesis it follows that

$$i(T) + 1 \leq i(T') + 2 < \gamma_2(T') + 1 = \frac{n-1}{2} + 1 = \frac{n+1}{2} = \gamma_2(T).$$

Therefore the only possible trees  $T$  of odd order with  $\gamma_2(T) = i(G) + 1$  are those with  $dm(T) \leq 6$ .

*Case 2.* Assume that  $n$  is even. Then  $\gamma_2(T) = (n+2)/2$  and from Corollary 3.35 we obtain that  $T$  consists of two subdivision trees  $T_1$  and  $T_2$  of other two trees and  $T_1$  and  $T_2$  are connected by a further edge  $uv$  where  $u \in V(T_1)$  and  $v \in V(T_2)$ . Additionally,  $n(T_1)$  and  $n(T_2)$  are both odd and, by Corollary 3.33,  $\gamma_2(T_1) = (n(T_1) + 1)/2$  and  $\gamma_2(T_2) = (n(T_2) + 1)/2$ .

*Case 2.1* Assume that  $n(T_1) \geq 3$  and  $n(T_2) \geq 3$ . Let  $A_1$  and  $A_2$  be the smaller sets of the bipartition sets of  $T_1$  and  $T_2$ , respectively. Then  $A_1$  is an independent dominating set of  $T_1$  and  $A_2$  an independent dominating set of  $T_2$ . If  $u \notin A_1$  or  $v \notin A_2$ , then  $A_1 \cup A_2$  is an independent dominating set of  $T$  and thus

$$i(T) \leq |A_1| + |A_2| \leq \frac{n(T_1) - 1}{2} + \frac{n(T_2) - 1}{2} = \frac{n+2}{2} - 2 = \gamma_2(T) - 2,$$

which is a contradiction. Hence, let  $u \in A_1$  and  $v \in A_2$  and, since  $T_1$  and  $T_2$  are subdivision trees and  $A_1$  and  $A_2$  are the smaller partite sets of  $T_1$  and  $T_2$ ,  $d_{T_1}(u) = 2$  and  $d_{T_2}(v) = 2$ . Then, if we regard  $T_2 - v$ , it consists of two subdivision trees  $T'_2$  and  $T''_2$ . Suppose that  $n(T'_2) \geq 3$  and  $n(T''_2) \geq 3$  and let  $A'_2$  and  $A''_2$  be the smaller partite sets of the bipartitions of  $T'_2$  and  $T''_2$ , respectively. Then  $A_1 \cup A'_2 \cup A''_2$  is an independent dominating set of  $T$  and thus

$$\begin{aligned} i(T) \leq |A_1| + |A'_2| + |A''_2| &\leq \frac{n(T_1) - 1}{2} + \frac{n(T'_2) - 1}{2} + \frac{n(T''_2) - 1}{2} \\ &= \frac{n-4}{2} = \frac{n+2}{2} - 3 = \gamma_2(T) - 3, \end{aligned}$$

which is a contradiction. Now assume that  $n(T'_2) = 1$  or  $n(T''_2) = 1$ . Suppose that  $n(T'_2) = 1$  and  $n(T''_2) \geq 3$ . Let  $V(T'_2) = \{w\}$ . Then, if  $A''_2$  is again the

smaller partite set of the bipartition of  $T_2''$ ,  $A_1 \cup A_2'' \cup \{w\}$  is an independent dominating set of  $T$  and thus

$$\begin{aligned} i(T) &\leq |A_1| + |A_2'| + 1 \leq \frac{n(T_1) - 1}{2} + \frac{n(T_2') - 1}{2} + 1 \\ &= \frac{n - 4}{2} + 1 = \frac{n + 2}{2} - 2 = \gamma_2(T) - 2, \end{aligned}$$

again a contradiction. It follows that  $n(T_2') = n(T_2'') = 1$ . Because of the symmetry, the same follows for  $T_1$  and thus  $T$  is isomorphic to the graph  $J$  illustrated in Figure 3.3.

*Case 2.2* Assume that  $T_1$  is the trivial graph. We distinguish now with respect to the diameter  $dm(T_2)$  of  $T_2$  four cases.

(i) If  $dm(T_2) = 0$ , then  $T_2$  is the trivial graph and  $T$  consists only of the edge  $uv$ , that is,  $T$  is a subdivided star  $SS_1$  without a leaf and  $\gamma_2(T) = \gamma(T) + 1 = 2$ .

(ii) Let  $dm(T_2) = 2$ . Then  $T_2$  is a path of length 2. If  $uv$  would be incident to the central vertex of  $T_2$ , we would have  $i(T) = 1$  and  $\gamma_2(T) = 3$ , which is not allowed. Therefore  $uv$  has to be incident to a leaf of  $T_2$  and hence  $T$  is a path of length 3, that is, the subdivided star  $SS_2$  without a leaf and  $\gamma_2(T) = \gamma(T) + 1 = 3$ .

(iii) Let  $dm(T_2) = 4$ . Then  $T_2$  is a subdivided star  $SS_t$  for an integer  $t \geq 2$ . If  $uv$  would be incident to a leaf or with a vertex  $x \neq z$  in  $T_2$ , where  $z$  is the central vertex of  $T_2$ , then  $\gamma_2(T) = t + 2$  and  $i(T) = t$  and the assumption  $\gamma_2(T) = i(T) + 1$  would be contradicted. Therefore  $uv$  has to be incident to the central vertex  $z$  of  $T_2$ . In this case  $T$  is the subdivided star  $SS_{t+1}$  without a leaf and  $\gamma_2(T) = \gamma(T) + 1 = t + 1$ .

(iv) Suppose  $dm(T_2) \geq 6$ . We will show by induction on  $n$  that in such a case the assumption  $\gamma_2(T) = i(T) + 1$  cannot be satisfied. Let  $dm(T_2) = 6$ . Then  $T_2$  is a subdivided double star  $SS_{s,t}$ . By analyzing which vertices of  $V(T_2)$  the edge  $uv$  could be incident to, one can easily show that  $\gamma_2(T) = i(T) + 2$  holds always. Let now  $dm(T_2) \geq 8$ . Let  $x$  be a leaf in  $T_2$  and  $y$  its support vertex such that  $u \notin N_T(\{x, y\})$ . Then  $T_2 - \{x, y\}$  is again a subdivided graph of diameter at least 6 and by the induction hypothesis we know that in  $T' = T - \{x, y\}$  the inequality  $\gamma_2(T') \geq i(T') + 2$  holds. Thus if  $I'$  is a  $i(T')$ -set, then  $I' \cup \{x\}$  is an independent dominating set of  $T$  and

hence it is not difficult to see that

$$i(T) \leq i(T') + 1 \leq \gamma_2(T') - 1 \leq \gamma_2(T) - 2.$$

Because of the symmetry, we do not have to distinguish more cases and thus  $\gamma_2(T) = \gamma(T) + 1$  or  $T$  is isomorphic to the graph in Figure 3.3.  $\square$

**Corollary 3.38** (Hansberg, Volkmann [42]) *Let  $T$  be a non-trivial tree of order  $n$ . Then  $\gamma_2(T) = i(G) + 1$  if and only if  $T$  is a subdivided star  $SS_t$  or a subdivided star  $SS_t$  minus a leaf or a subdivided double star  $SS_{s,t}$  or  $T$  is isomorphic to the graph showed in Figure 3.3.*

**Proof.** This follows directly from Theorems 3.27 and 3.37.  $\square$

Now we focus on graphs with equal 2-domination and independent domination numbers.

**Theorem 3.39** (Hansberg, Volkmann [42]) *Let  $G$  be a non-trivial connected block-cactus graph. Then  $\gamma_2(G) = i(G)$  if and only if  $G$  is a  $C_4$ -cactus.*

**Proof.** By Corollary 3.31,  $G$  is a block-cactus graph whose blocks are all  $C_4$ -cycles. If  $G$  consists of only one block, then  $G \cong C_4$ . If  $G$  has a cut vertex, then there is an end block  $C$  isomorphic to the cycle  $C_4$ . Let  $u$  be the cut vertex of  $C$  in  $G$ . Then it is easy to see for the graph  $G' := G - (V(C) - \{u\})$  that

$$\gamma_2(G') \leq \gamma_2(G) - 1 = i(G) - 1 \leq i(G'),$$

and together with Theorem 3.26 we have that  $\gamma_2(G') = i(G')$ . Now consider the following graph  $F$ .

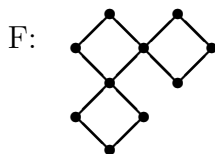

Here  $\gamma_2(F) = 5 = i(F) + 1$  holds. Note that the block-cactus  $G$  is a  $C_4$ -cactus if and only if every block of  $G$  is a  $C_4$ -cycle and  $G$  does not contain the graph  $F$  as a subgraph. Hence, if  $G$  would not be a  $C_4$ -cactus, we could reduce  $G$  to the graph  $F$  by taking away  $C_4$ -end cycles one after the other. According to our previous analysis, every reduction  $G'$  of  $G$  should satisfy  $\gamma_2(G') = i(G')$ . Hence,  $\gamma_2(F)$  has to be equal to  $i(F)$ , which is a contradiction. It is now

evident that  $G$  has to be a  $C_4$ -cactus.  $\square$

Because of the inequality chain  $\gamma_2 \geq i \geq \gamma$  for block-cactus graphs and since the  $C_4$ -cactus graphs fulfill always  $\gamma = \gamma_2$ , it follows that

$$\gamma_2(G) = i(G) \Leftrightarrow \gamma_2(G) = \gamma(G)$$

for every block-cactus graph  $G$ . Thus, we obtain again as a corollary to this theorem the characterization of all connected block-cactus graphs  $G$  with  $\gamma_2(G) = \gamma(G)$  (see Theorem 2.50).

Moreover, for graphs  $G$  with  $\gamma(G) = i(G)$  it holds also  $\gamma_2(G) = \gamma(G)$  if and only if  $\gamma_2(G) = i(G)$ . Claw-free graphs have this property (see [1]). Therefore, with our Theorems 2.53 and 2.55 of previous chapter, we obtain the characterization of the claw-free graphs and the line-graphs  $G$  with  $\gamma_2(G) = i(G)$ .

We finish this section with an observation, for which we need the next lemma of Randerath and Volkmann.

**Lemma 3.40** (Randerath, Volkmann [59], 1998) *Let  $G$  be a connected  $C_4$ -cactus with the partite sets  $A$  and  $B$ . If  $|A| \leq |B|$ , then  $|A| = \gamma(G) = \beta(G)$  and  $|B| = 2|A| - 2$ .*

**Observation 3.41** (Hansberg, Volkmann [42]) *Let  $G$  be a connected  $C_4$ -cactus with partite sets  $A$  and  $B$  and  $|A| \leq |B|$ . Then the following properties are satisfied:*

- (i)  $A$  is a  $\gamma(G)$ -, a  $\gamma_2(G)$ -, an  $i(G)$ - and a  $\beta(G)$ -set.
- (ii) If  $n(G) \geq 7$ , then  $A$  is the only  $\gamma_2(G)$ - and  $\beta(G)$ -set of  $G$ .

**Proof.** (i) By Lemma 3.40 we know that  $|A| = \gamma(G) = \beta(G)$  and we already observed that  $\gamma_2(G) = i(G) = \gamma(G)$ . Thus  $|A| = \gamma_2(G) = \gamma(G) = i(G) = \beta(G)$ . Moreover, since every vertex  $x \in B$  has degree  $d_G(x) \geq 2$  and  $N_G(V(B)) = A$ ,  $A$  is a 2-dominating set in  $G$  and thus dominating and, for being a partite set, it is independent. Evidently  $A$  is also a covering of  $G$  and hence (i) follows.

(ii) We will prove the statement by induction on  $n = n(G)$ . If  $n(G) = 7$ , then we have a  $C_4$ -cactus which consists of two  $C_4$ -cycles that have exactly one vertex in common. Then  $|A| = 3 < |B| = 4$  and  $A$  is the only  $\gamma_2(G)$ - and  $\beta(G)$ -set of  $G$ . Observe that all vertices  $x \in V(G)$  with  $d_G(x) > 2$  are contained in  $A$ .

Now suppose that  $n(G) > 7$ . Let  $C$  be an end block of  $G$  with cut vertex  $u$  in  $G$ . Then the graph  $G' := G - (V(C) - \{u\})$  is again a  $C_4$ -cactus graph but with less vertices than  $G$ . If  $A'$  and  $B'$  are partite sets of  $G'$  with  $|A'| \leq |B'|$ , then it follows by the induction hypothesis that  $A'$  is the unique  $\gamma_2(G')$ - and  $\beta(G')$ -set of  $G'$  and that all vertices  $x \in V(G')$  with  $d_{G'}(x) > 2$  are contained in  $A'$ . It is now evident from the definition of a  $C_4$ -cactus that  $u \in A'$ ,  $|A| = |A'| + 1$  and  $|B| = |B'| + 2$  and that  $A$  is both a 2-dominating set and a coverig of  $G$ . Since  $\gamma_2(G) \geq \gamma_2(G') + 1$  and  $\beta(G) \geq \beta(G') + 1$ , it follows that  $A$  is both a  $\gamma_2(G)$ - and a  $\beta(G)$ -set of  $G$ . It is also the only  $\gamma_2(G)$ - and  $\beta(G)$ -set of  $G$  since otherwise would exist a  $\gamma_2(G')$ - and a  $\beta(G')$ -set different from  $A'$ . □

### 3.4 The $k$ -domination number and the matching number

A set of pairwise not incident edges of a graph  $G$  is called a *matching*. A matching  $M_0$  with maximum number of edges is a *maximum matching* and the number  $\alpha_0(G) = |M_0|$  is called the *matching number* of  $G$ . Let  $M$  be a matching of a graph  $G$ . A path is said to be  *$M$ -alternating* if its edges belong alternatively to  $M$  and not to  $M$ .

Volkman showed in [69] that, if  $T$  is a nontrivial tree, then  $\gamma_2(T) \geq \beta(T) + 1$ , and he characterized all such trees with  $\gamma_2(T) = \beta(T) + 1$ . This implies that

$$\gamma_2(T) \geq \beta(T) + 1 \geq \alpha_0(T) + 1.$$

Applying the well-known identity  $\beta(G) = \alpha_0(G)$  of König [50] for every bipartite graph  $G$ , we observe that, for a nontrivial tree  $T$ ,  $\gamma_2(T) = \beta(T) + 1$  if and only if  $\gamma_2(T) = \alpha_0(T) + 1$ . As an extension of the inequality  $\gamma_2(T) \geq \alpha_0(T) + 1$  for nontrivial trees  $T$ , we will show that  $\gamma_2(G) \geq \alpha_0(G) + 1$  for all connected cactus graphs  $G$  without cycles of even length and for all cactus graphs  $G$  of odd order and one even cycle. But first, we need some more theory.

Recall that a bipartite graph  $G$  is called  *$k$ -semiregular* if its vertex set can be bipartitioned in such a way that every vertex of one of the partite sets has degree  $k$ . We already presented Fink and Jacobson's [27] bound

$$\gamma_k(G) \geq n - \frac{m}{k} \tag{3.3}$$

for a graph  $G$  with  $n$  vertices and  $m$  edges (see Theorem 1.4). Here, if  $m \neq 0$ , then  $\gamma_k(G) = n - \frac{m}{k}$  if and only if  $G$  is a  $k$ -semiregular graph. Now we will

prove a similar theorem, introducing a new parameter  $\mu_o(G)$ , which stands for the minimum number of edges that can be removed from a graph  $G$  such that the remaining graph is bipartite.

**Theorem 3.42** (Hansberg, Volkmann [40], 2009) *Let  $G$  be a graph of order  $n$  and size  $m$  and let  $\mu_o = \mu_o(G)$ . Then*

$$\gamma_k(G) \geq n - \frac{m - \mu_o}{k}.$$

*Additionally, if  $m \neq 0$ , then  $\gamma_k(G) = \lceil n - \frac{m - \mu_o}{k} \rceil$  if and only if  $G$  contains a  $k$ -semiregular factor  $H$  with  $m(H) = m - \mu_o - r$ , where  $r$  is an integer such that  $0 \leq r \leq k - 1$  and  $m - \mu_o - r \equiv 0 \pmod{k}$ .*

**Proof.** Let  $V = V(G)$  and let  $D$  be a  $\gamma_k(G)$ -set. Let  $K = (D, D) \cup (V - D, V - D)$ . Since  $G - K$  contains no odd cycles, it follows that  $|K| \geq \mu_o$ . As every vertex in  $V - D$  has at least  $k$  neighbors in  $D$ , it follows

$$\begin{aligned} m &= m(D, V - D) + |K| \geq k |V - D| + |K| \\ &\geq k |V - D| + \mu_o = k(n - \gamma_k(G)) + \mu_o \end{aligned}$$

and consequently we obtain

$$\gamma_k(G) \geq n - \frac{m - \mu_o}{k}.$$

Now assume that  $m \neq 0$ . Suppose first that  $\gamma_k(G) = n - \frac{m - \mu_o - r}{k}$  for an integer  $r$  with  $0 \leq r \leq k - 1$ . Since  $m - \mu_o \neq 0$ , it follows that  $\gamma_k(G) \leq n - 1$  and thus  $V - D$  can never be empty. Let  $H$  be the  $k$ -semiregular factor of  $G$  such that the vertex sets  $D$  and  $V - D$  are both independent sets and every vertex in  $V - D$  has exactly degree  $k$ . Since  $D$  is still a  $k$ -dominating set of  $H$ , we obtain

$$\gamma_k(H) = \gamma_k(G) = n - \frac{m - \mu_o - r}{k} = n - \frac{(n - \gamma_k(G))k}{k} = n - \frac{m(H)}{k}.$$

It follows that  $m(H) = m - \mu_o - r$ .

Conversely, assume that  $G$  has a  $k$ -semiregular factor  $H$  with  $m(H) = m - \mu_o - r$  for an integer  $r$  such that  $0 \leq r \leq k - 1$  and  $m - \mu_o - r \equiv 0 \pmod{k}$ . Let  $S$  be the partition set in  $H$  of vertices of degree  $k$ . Then  $|S| = m(H)/k$  and  $V - S$  is a  $k$ -dominating set of  $H$ . This implies

$$\gamma_k(H) \leq |V - S| = n - |S| = n - \frac{m(H)}{k}$$

and thus, together with (3.3),  $V - S$  is a  $\gamma_k(H)$ -set. Since  $V - S$  is also a  $k$ -dominating set of  $G$ , we obtain

$$\gamma_k(G) \leq |V - S| = n - \frac{m(H)}{k} = n - \frac{m - \mu_o - r}{k}$$

and so  $\gamma_k(G) = n - \frac{m - \mu_o - r}{k} = \lceil n - \frac{m - \mu_o}{k} \rceil$  follows. □

**Observation 3.43** (Hansberg, Volkmann [40], 2009) *Let  $G$  be a connected graph and let  $T$  be a spanning tree of  $G$  with partition sets  $A$  and  $B$ . Since  $T$  contains no cycles, it is obvious that  $\mu_o(G) \leq m_G(A, A) + m_G(B, B)$ . Let now  $K$  be a set of edges of  $G$  such that  $|K| = \mu_o(G)$  and  $G - K$  is bipartite and let  $A'$  and  $B'$  be the partition sets of  $G - K$ . Then  $G - K$  is connected and every edge  $e \in K$  belongs either to  $(A', A')$  or to  $(B', B')$ , otherwise it would contradict the minimality of  $\mu_o(G)$ . Conversely, every edge  $e \in (A', A') \cup (B', B')$  belongs to  $K$ . This shows that  $\mu_o(G) = |K| = m_G(A', A') + m_G(B', B')$ . It follows that there is a spanning tree with bipartition sets  $A'$  and  $B'$  and  $\mu_o(G) = m_G(A', A') + m_G(B', B')$  and consequently*

$$\mu_o(G) = \min\{m_G(A, A) + m_G(B, B) \mid A, B \text{ partition sets of a spanning tree of } G\}.$$

Since for cactus graphs  $G$  the parameter  $\mu_o(G)$  equals the number of odd cycles  $\nu_o(G)$  in  $G$ , we obtain the following corollary from Theorem 3.42.

**Corollary 3.44** (Hansberg, Volkmann [40], 2009) *Let  $G$  be a connected cactus graph of order  $n$ , size  $m$  and  $\nu_o$  cycles of odd length. If  $k \geq 1$  is an integer, then*

$$\gamma_k(G) \geq n - \frac{m - \nu_o}{k}$$

and, if  $m \neq 0$ , then  $\gamma_k(G) = \lceil n - \frac{m - \nu_o}{k} \rceil$  if and only if  $G$  has a  $k$ -semiregular factor  $H$  with  $m(H) = m - \nu_o - r$  for an integer  $r$  with  $0 \leq r \leq k - 1$  and  $m - \nu_o - r \equiv 0 \pmod{k}$ .

**Corollary 3.45** (Hansberg, Volkmann [40], 2009) *Let  $G$  be a connected cactus graph of order  $n$ , size  $m$  and  $\nu_e$  cycles of even length. If  $k \geq 1$  is an integer, then*

$$\gamma_k(G) \geq \frac{(k - 1)n - \nu_e + 1}{k}.$$

**Proof.** This follows directly from Corollary 3.44 and the well known identity  $m = n + \nu_e + \nu_o - 1$  for cactus graphs. □

The next lemma will be useful in proving our results about cactus graphs and the matching number.

**Lemma 3.46** (Hansberg, Volkmann [40], 2009) *Let  $G$  be the subdivision graph of a connected multigraph  $H$  and  $n = n(G)$ . Then  $\gamma_2(G) = \alpha_0(G)$  when  $n$  is even and  $\alpha_0(G) \leq \gamma_2(G) \leq \alpha_0(G) + 1$  when  $n$  is odd.*

**Proof.** It is evident that the sets  $A := V(H)$  and  $B := V(G) - V(H)$  form a bipartition of  $G$  where all vertices in  $B$  are of degree 2, that is,  $G$  is a 2-semiregular simple graph. Since  $A$  is a 2-dominating set,

$$\gamma_2(G) \leq |A| = n(G) - \frac{m(G)}{2}$$

holds and thus (3.3) implies that  $A$  is a  $\gamma_2(G)$ -set. Then it is clear that  $\alpha_0(G) \leq \gamma_2(G)$ . Let  $M$  be a maximum matching of  $G$  and suppose that  $\gamma_2(G) > \alpha_0(G)$ . It follows that there has to be a vertex  $u \in A$  such that  $u \notin V(M)$ . If  $n$  is even, this implies that there is another vertex  $v \neq u$  such that  $v \notin V(M)$ . If  $n$  is odd, assume that there is another vertex  $v \neq u$  such that  $v \notin V(M)$ . Let  $x$  be the first vertex in a path  $P$  from  $u$  to  $v$  in  $G$  such that  $x \notin V(M)$  and let  $P_{ux}$  be the part of the path  $P$  from  $u$  to  $x$ . It follows that  $x \in B$ , otherwise would  $P_{ux}$  be of even length and either  $x$  should be in  $V(M)$  or there would be a vertex before  $x$  in  $P_{ux}$  that does not belong to  $V(M)$  (remember that every vertex in  $B$  has degree 2). But then  $(M - E(P_{ux})) \cup (E(P_{ux}) - M)$  is a matching in  $G$  with one more edge than  $M$  and we obtain a contradiction. It follows that  $\gamma_2(G) = \alpha_0(G)$  when  $n$  is even, and that  $\gamma_2(G) \leq \alpha_0(G) + 1$  when  $n$  is odd.  $\square$

**Corollary 3.47** (Hansberg, Volkmann [40], 2009) *Let  $G$  be the subdivision graph of a connected multigraph. If  $G$  has odd order and  $\gamma_2(G) = \alpha_0(G) + 1$ , then  $G$  contains an almost perfect matching.*

**Proof.** Since  $\gamma_2(G) = \alpha_0(G) + 1$ , following the proof of Lemma 3.46, this implies that  $A = (V(M) \cap A) \cup \{u\}$  and  $B = V(M) \cap B$  and the proof is complete.  $\square$

Now we can concentrate on cactus graphs.

**Theorem 3.48** (Hansberg, Volkmann [40], 2009) *If  $G$  is a connected cactus graph of order  $n$  with  $\nu_e$  cycles of even length, then*

$$\gamma_2(G) \geq \alpha_0(G) + 1 - \left\lceil \frac{\nu_e}{2} \right\rceil, \quad (3.4)$$

and if  $n$  and  $\nu_e$  are both odd, then

$$\gamma_2(G) \geq \alpha_0(G) + 2 - \left\lceil \frac{\nu_e}{2} \right\rceil. \quad (3.5)$$

**Proof.** Corollary 3.45 implies

$$\gamma_2(G) \geq \frac{n + 1 - \nu_e}{2}. \tag{3.6}$$

Using the fact that  $\alpha_0(G) \leq \frac{n}{2}$ , it follows from (3.6) that

$$\gamma_2(G) \geq \alpha_0(G) + \frac{1 - \nu_e}{2}$$

and thus (3.4). If  $n$  is odd, then  $\alpha_0(G) \leq \frac{n-1}{2}$ , and we deduce from (3.6) that

$$\gamma_2(G) \geq \alpha_0(G) + \frac{2 - \nu_e}{2}.$$

This leads to (3.5) when  $\nu_e$  is odd, and the proof is complete. □

In the following figures we present examples which show that Theorem 3.48 is best possible.

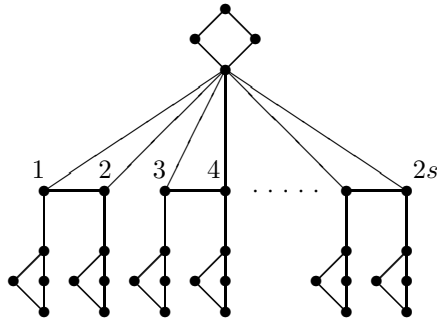

Figure 3.4: Graph of even order and odd number of cycles of even length with equality in (3.4).

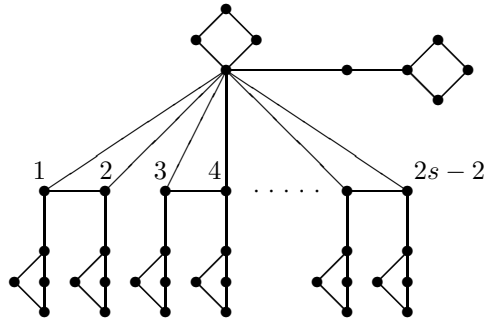

Figure 3.5: Graph of odd order and even number of cycles of even length with equality in (3.4).

The cactus graph in Figure 3.4 is of even order  $n = 10s + 4$  with an odd number  $\nu_e = 2s + 1$  of cycles of even length such that  $\gamma_2 = 4s + 2$  and  $\alpha_0 = 5s + 2$  and therefore equality in (3.4).

The cactus graph in Figure 3.5 is of odd order  $n = 10s - 1$  with an even number  $\nu_e = 2s$  of cycles of even length such that  $\gamma_2 = 4s$  and  $\alpha_0 = 5s - 1$  and therefore equality in (3.4).

The cactus graph in Figure 3.6 is of even order  $n = 10s$  with an even number  $\nu_e = 2s$  of cycles of even length such that  $\gamma_2 = 4s + 1$  and  $\alpha_0 = 5s$  and therefore equality in (3.4).

The cactus graph in Figure 3.7 is of odd order  $n = 10s + 5$  with an odd number  $\nu_e = 2s + 1$  of cycles of even length such that  $\gamma_2 = 4s + 3$  and  $\alpha_0 = 5s + 2$  and therefore equality in (3.5).

For cactus graphs with at most one cycle of even length, we can prove the following result.

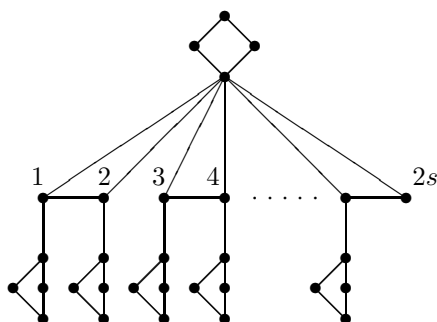

Figure 3.6: Graph of even order and even number of cycles of even length with equality in (3.4).

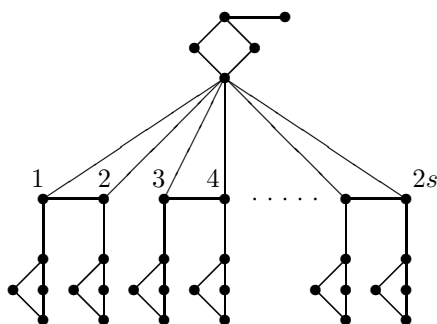

Figure 3.7: Graph of odd order and odd number of cycles of even length with equality in (3.5).

**Theorem 3.49** (Hansberg, Volkmann [40], 2009) *Let  $G$  be a connected cactus graph of order  $n$  and size  $m$  and let  $\nu_e = \nu_e(G)$  and  $\nu_o = \nu_o(G)$ . Then the following holds.*

- (i) *If  $n$  is odd and  $\nu_e \leq 1$ , then  $\gamma_2(G) \geq \alpha_0(G) + 1$  and  $\gamma_2(G) = \alpha_0(G) + 1$  if and only if  $G$  has a 2-semiregular factor  $H$  with  $m(H) = m - \nu_o - \nu_e$ .*
- (ii) *If  $n$  is even and  $\nu_e = 1$ , then  $\gamma_2(G) \geq \alpha_0(G)$  and  $\gamma_2(G) = \alpha_0(G)$  if and only if  $G$  has a 2-semiregular factor  $H$  with  $m(H) = m - \nu_o$ .*
- (iii) *If  $n$  is even and  $\nu_e = 0$ , then  $\gamma_2(G) \geq \alpha_0(G) + 1$  and  $\gamma_2(G) = \alpha_0(G) + 1$  if and only if  $G$  has a 2-semiregular factor  $H$  with  $m(H) = m - \nu_o - 1$ .*

**Proof.** (i) Let  $n$  be odd and  $\nu_e \leq 1$ . From Theorem 3.48 follows directly  $\gamma_2(G) \geq \alpha_0(G) + 1$ . Assume now that  $\gamma_2(G) = \alpha_0(G) + 1$ . Then Corollary

3.45 leads to

$$\alpha_0(G) + 1 = \gamma_2(G) \geq \left\lceil \frac{n - \nu_e + 1}{2} \right\rceil = \frac{n + 1}{2} \geq \alpha_0(G) + 1.$$

This implies  $\gamma_2(G) = \lceil \frac{n - \nu_e + 1}{2} \rceil$ , which is the same as  $n - \frac{m - \nu_o}{2}$ , if  $\nu_e = 0$ , and the same as  $n - \frac{m - \nu_o - 1}{2}$ , if  $\nu_e = 1$ . It follows that  $\gamma_2(G) = n - \frac{m - \nu_o - \nu_e}{2}$  and so, by Theorem 3.42,  $G$  contains a 2-semiregular factor  $H$  with  $m(H) = m - \nu_o - \nu_e$ .

Conversely, assume that  $G$  contains a 2-semiregular factor  $H$  with  $m(H) = m - \nu_o - \nu_e$ . It is easy to see that  $H$  is the subdivision graph of a particular multigraph. Since  $H$  is bipartite, at least  $\nu_o$  edges from  $E(G) - E(H)$  belong to pairwise different odd cycles of  $G$  and hence, as  $\nu_e \leq 1$ ,  $H$  consists of at most two components, in such a case is one of them odd and the other one even. Thus Lemma 3.46 leads to  $\alpha_0(H) \leq \gamma_2(H) \leq \alpha_0(H) + 1$ . According to (3.4) and (3.5), we obtain

$$\alpha_0(G) + 1 \geq \alpha_0(H) + 1 \geq \gamma_2(H) \geq \gamma_2(G) \geq \alpha_0(G) + 1$$

and hence  $\gamma_2(G) = \alpha_0(G) + 1$ .

(ii) Let  $n$  be even and  $\nu_e = 1$ . From Theorem 3.48 follows directly that  $\gamma_2(G) \geq \alpha_0(G)$ . Suppose that  $\gamma_2(G) = \alpha_0(G)$ . Then, again Corollary 3.45 yields

$$\alpha_0(G) = \gamma_2(G) \geq \left\lceil \frac{n + 1 - \nu_e}{2} \right\rceil = \frac{n}{2} \geq \alpha_0(G).$$

This leads to the fact that  $\gamma_2(G) = n - \frac{m - \nu_o}{2}$ . Hence, applying Theorem 3.42,  $G$  has a 2-semiregular factor  $H$  with  $m(H) = m - \nu_o$ .

Conversely, assume that  $G$  has a 2-semiregular factor  $H$  with  $m(H) = m - \nu_o$ . As above,  $H$  is the subdivision graph of a particular multigraph. Since  $H$  is a bipartite cactus graph, the set  $E(G) - E(H)$  contains exactly one edge of every odd cycle in  $G$  and thus  $H$  is connected. It follows with Theorem 3.48 and Lemma 3.46 that

$$\alpha_0(G) \geq \alpha_0(H) = \gamma_2(H) \geq \gamma_2(G) \geq \alpha_0(G),$$

which implies  $\alpha_0(G) = \gamma_2(G)$ .

(iii) Let  $n$  be even and  $\nu_e = 0$ . Theorem 3.48 implies that  $\gamma_2(G) \geq \alpha_0(G) + 1$ . Assume first that  $\gamma_2(G) = \alpha_0(G) + 1$ . Then, applying once more Corollary 3.45, it follows

$$\alpha_0(G) + 1 = \gamma_2(G) \geq \left\lceil \frac{n + 1 - \nu_e}{2} \right\rceil = \frac{n + 2}{2} \geq \alpha_0(G) + 1,$$

which implies that  $\gamma_2(G) = n + \frac{\nu_o - m + 1}{2}$  and thus  $G$  has a 2-semiregular factor with  $m(H) = m - \nu_o - 1$ . Conversely, suppose that  $G$  has a 2-semiregular factor with  $m(H) = m - \nu_o - 1$ . With the same arguments as above,  $H$  consists of exactly two components. If  $\gamma_2(H) = \alpha_0(H)$ , then it follows, together with (3.4),

$$\alpha_0(G) \geq \alpha_0(H) = \gamma_2(H) \geq \gamma_2(G) \geq \alpha_0(G) + 1,$$

which is a contradiction. Therefore, regarding Lemma 3.46,  $H$  has two odd components  $H_1$  and  $H_2$  with  $\gamma_2(H_i) = \alpha_0(H_i) + 1$  for at least one  $i \in \{1, 2\}$ . If, say,  $\gamma_2(H_1) = \alpha_0(H_1)$ , then  $\gamma_2(H_2) = \alpha_0(H_2) + 1$  and thus, together with (3.4),

$$\begin{aligned} \alpha_0(G) + 1 &\geq \alpha_0(H) + 1 = \alpha_0(H_1) + \alpha_0(H_2) + 1 \\ &= \gamma_2(H_1) + \gamma_2(H_2) = \gamma_2(H) \geq \gamma_2(G) \geq \alpha_0(G) + 1, \end{aligned}$$

which means that  $\gamma_2(G) = \alpha_0(G) + 1$ . Let now  $\gamma_2(H_i) = \alpha_0(H_i) + 1$  for  $i = 1, 2$ . Let  $uv$  be an edge in  $G$  such that  $H + uv$  is connected (there has to be such an edge since there are  $\nu_o$  different edges in  $E(G) - E(H)$  which belong to pairwise different odd cycles of  $G$ ). Let  $u \in V(H_1)$  and  $v \in V(H_2)$ . Let  $M'_1$  be a maximum matching in  $H_1$  and suppose that  $u \in V(M'_1)$ . Let  $D$  and  $V(H_1) - D$  be a bipartition of  $H_1$  such that  $D$  is a  $\gamma_2(H_1)$ -set and  $V(H_1) - D$  consists of vertices of degree 2. Since  $\gamma_2(H_1) = \alpha_0(H_1) + 1$ , there is a vertex  $x \in D$  such that  $x \notin V(M'_1)$ . As  $H_1$  is a connected bipartite graph and since  $M'_1$  is an almost perfect matching in  $H_1$  (see Corollary 3.47) and every vertex in  $V(H_1) - D$  has degree 2 in  $H_1$ , it follows that there is an  $M'_1$ -alternating path  $P$  from  $x$  to  $v$ . Then  $M_1 = (M'_1 - E(P)) \cup (E(P) - M'_1)$  is also a maximum matching of  $H_1$  with  $u \notin V(M_1)$ . Analogously, there is a maximum matching  $M_2$  of  $H_2$  such that  $v \notin V(M_2)$ . It follows that  $M = M_1 \cup M_2 \cup \{uv\}$  is a matching in  $G$  and so, with (3.4),

$$\alpha_0(G) + 1 \geq \alpha_0(H) + 2 = \gamma_2(H) \geq \gamma_2(G) \geq \alpha_0(G) + 1,$$

which implies that  $\gamma_2(G) = \alpha_0(G) + 1$ . □

Since unicyclic graphs are cactus graphs with exactly one cycle, we obtain following corollary.

**Corollary 3.50** (Hansberg, Volkmann [40], 2009) *Let  $G$  be a connected unicyclic graph of order  $n$ .*

- (i) *If  $n$  is odd, then  $\gamma_2(G) \geq \alpha_0(G) + 1$  and  $\gamma_2(G) = \alpha_0(G) + 1$  if and only if there is an edge  $e \in E(G)$  such that  $G - e$  is the subdivision graph of a unicyclic multigraph.*

- (ii) If  $n$  and the unique cycle of  $G$  are both even, then  $\gamma_2(G) \geq \alpha_0(G)$  and  $\gamma_2(G) = \alpha_0(G)$  if and only if  $G$  is the subdivision graph of a unicyclic multigraph.
- (iii) If  $n$  is even and the unique cycle of  $G$  is odd, then  $\gamma_2(G) \geq \alpha_0(G) + 1$  and  $\gamma_2(G) = \alpha_0(G) + 1$  if and only if there are two edges  $e, f \in E(G)$  such that  $G - \{e, f\}$  is the subdivision graph of a unicyclic multigraph.

**Proof.** Since a 2-semiregular unicyclic graph is a subdivision graph of a unicyclic multigraph and vice versa, the statements (i) - (iii) follow directly from Theorem 3.49.  $\square$

### 3.5 Connected, total and $k$ -domination

A subset  $D \subseteq V(G)$  is a  $k$ -star-forming set of  $G$  if for each vertex  $u$  in  $V - D$  with less than  $k$  neighbors in  $D$ ,  $N(u) \cap D \neq \emptyset$  and at least one vertex of  $N(u) \cap D$  has at least  $k - 1$  neighbors in  $D$ . This means that every vertex  $u$  of  $V - D$  is contained in a (not necessarily induced)  $k$ -star  $K_{1,k}$  of the subgraph induced by  $D \cup \{u\}$ . The minimum cardinality of a  $k$ -star-forming set of  $G$  is denoted  $sf_k(G)$ . As every  $k$ -dominating set is a  $k$ -star-forming set,  $\gamma_k(G) \geq sf_k(G)$  for every graph  $G$  and every positive integer  $k$ . Note that  $sf_1(G) = \gamma_1(G) = \gamma(G)$  for every graph  $G$ . The concept of  $k$ -star-forming set was introduced by Chellali and Favaron in [15]. A subset  $S \subseteq V(G)$  is said to be a *total dominating set* if every vertex in  $V(G)$  has at least one neighbor in  $S$  and it is a *connected dominating set*, if it is a dominating set and the graph induced by  $S$  is connected. The *total domination number*  $\gamma_t(G)$  and the *connected domination number*  $\gamma_c(G)$  represent the cardinality of a minimum total dominating set and of a minimum connected dominating set of  $G$ , respectively. In [15], Chellali and Favaron obtained the following result.

**Theorem 3.51** (Chellali, Favaron [15]) *Every nontrivial connected triangulated graph  $G$  satisfies  $sf_2(G) = \gamma_t(G)$ .*

Considering the total domination number  $\gamma_t$  in block graphs, we can give a similar result to the one of Fink and Jacobson in Theorem 1.3. This will follow from the next theorem.

**Theorem 3.52** (Chellali, Favaron, Hansberg, Volkmann [16]) *Let  $G$  be a connected  $\{C_4, K_4 - e\}$ -free graph and  $k, q$  two integers such that  $2 \leq q \leq k \leq \Delta(G)$ . Then  $\gamma_k(G) \geq sf_q(G) + k - q$ .*

**Proof.** If  $k = q$ , we already know that  $\gamma_k(G) \geq sf_k(G)$ . So assume  $k \geq q + 1$  and consider a  $\gamma_k(G)$ -set  $D$ . Since  $k \leq \Delta(G)$ ,  $V - D \neq \emptyset$ . Let  $v \in V - D$ ,  $A$  a subset of  $N(v) \cap D$  of size  $k - q + 1$ , and  $D' = (D - A) \cup \{v\}$ . Suppose that  $D'$  is not a  $q$ -star-forming set. Then there exists a vertex  $u$  in  $V - D' = A \cup (V - (D \cup \{v\}))$  having less than  $q$  neighbors in  $D'$  and such that every vertex of  $N(u) \cap D'$ , if any, has degree less than  $q - 1$  in  $D'$ . This vertex  $u$  cannot be in  $A$  since every vertex of  $A$  is adjacent to  $v \in D'$  and (as  $v$  is  $k$ -dominated by  $D$ )  $v$  has at least  $q - 1$  neighbors in  $D - A \subseteq D'$ . Therefore  $u \in V - (D \cup \{v\})$ . The vertex  $u$ , which has at least  $k$  neighbors in  $D$  but less than  $q$  in  $D' = (D - A) \cup \{v\}$ , is adjacent to every vertex in  $A$  but not to  $v$ . Since  $|A| = k - q + 1 \geq 2$ , the subgraph induced by  $A \cup \{u, v\}$  contains either an induced cycle  $C_4$  or a  $K_4$  minus an edge, contradicting the hypothesis on  $G$ . Thus  $D'$  is a  $q$ -star-forming set and  $sf_q(G) \leq |D'| = \gamma_k - k + q$ .  $\square$

As, by Theorem 3.51,  $sf_2(G) = \gamma_t(G)$  holds for every nontrivial triangulated graph  $G$ , we obtain from Theorem 3.52 with  $q = 2$  following corollary for block graphs.

**Corollary 3.53** (Chellali, Favaron, Hansberg, Volkmann [16]) *Let  $G$  be a nontrivial block graph. If  $\Delta(G) \geq k$  for an integer  $k \geq 2$ , then  $\gamma_k(G) \geq \gamma_t(G) + k - 2$ .*

For the block graphs  $G$  where  $\gamma_t(G) > \gamma(G)$ , this is a stronger result than Corollary 2.32. Now we will concentrate on trees, which are a special kind of block graphs.

**Theorem 3.54** (Chellali, Favaron, Hansberg, Volkmann [16]) *Let  $T$  be a tree with  $\Delta(T) \geq k \geq 3$  for an integer  $k$ . Then  $\gamma_k(T) \geq \gamma_c(T) + k - 1$  with equality if and only if  $T$  is a generalized star with  $k$  leaves or, in the case  $k = 3$ , if  $T$  has maximum degree 3 and no two vertices of degree 3 are adjacent to each other.*

**Proof.** Let  $\tau_i$  be the number of vertices of degree  $i$  in  $T$ ,  $\Delta = \Delta(T)$  and let  $L$  be the set of leaves in  $T$ . Since  $T$  is a tree,

$$\tau_1 = 2 + \sum_{i=3}^{\Delta} (i - 2)\tau_i \quad (3.7)$$

holds (see for example [68], p. 31). Because every  $k$ -dominating set contains all vertices of degree less than  $k$  and  $V(T) - L$  is a  $\gamma_c(T)$ -set of  $T$ , we deduce

that

$$\begin{aligned}
 \gamma_k(T) &\geq \sum_{i=1}^{k-1} \tau_i = 2 + \sum_{i=3}^{\Delta} (i-2)\tau_i + \sum_{i=2}^{k-1} \tau_i \\
 &= (n - \tau_1) + 2 + \sum_{i=3}^{k-1} (i-2)\tau_i + \sum_{i=k}^{\Delta} (i-3)\tau_i \\
 &\geq \gamma_c(T) + 2 + (\Delta - 3)\tau_{\Delta} \\
 &\geq \gamma_c(T) + 2 + (k - 3) = \gamma_c(T) + k - 1.
 \end{aligned}$$

*Case 1.* Assume that  $k \geq 4$ . It is a simple matter to verify that if  $T$  is a generalized star with  $k$  leaves, then  $\gamma_k(T) = \gamma_c(T) + k - 1$  holds. Assume now that  $\gamma_k(T) = \gamma_c(T) + k - 1$ . Then we obtain equality in the whole inequality chain above, in particular  $\Delta = k$ ,  $\tau_{\Delta} = \tau_k = 1$  and  $\tau_i = 0$  for  $3 \leq i \leq k - 1$ . We deduce that  $\gamma_k(T) = n - 1$  and the inequality chain implies

$$\gamma_c(T) + k - 1 = \gamma_k(T) = (n - \tau_1) + 2 + (k - 3) = n - 1,$$

which leads to  $\tau_1 = k$  and  $\gamma_c(T) = n - k$ . The tree  $T$  consists then of a vertex of degree  $k$ ,  $k$  vertices of degree 1 and the remaining vertices are of degree 2. It follows that  $T$  is a generalized star with  $k$  leaves.

*Case 2.* Assume that  $k = 3$ . If  $T$  has maximum degree  $\Delta(T) = 3$  and no two vertices of degree 3 are adjacent to each other, then it is easy to check that  $V(T) - L$  is a  $\gamma_c(T)$ -set and that  $V(T) - L_3$  is a  $\gamma_3(T)$ -set, where  $L_3$  is the set of vertices of degree 3. It follows with (3.7) that  $\gamma_3(T) = n - \tau_3 = n - \tau_1 + 2 = \gamma_c(T) + 2$ .

Conversely, assume that  $\gamma_3(T) = \gamma_c(T) + 2$ . It follows from the inequality chain that  $\Delta(T) = 3$  and  $\gamma_3(T) = \tau_1 + \tau_2$ . So, if  $L_2$  is the set of vertices with degree 2 in  $T$ , then  $L \cup L_2$  is a  $\gamma_3(T)$ -set and  $V(T) - L$  is a  $\gamma_c(T)$ -set. This implies that no two vertices of degree 3 can be adjacent to each other.  $\square$

If  $k \geq 3$ , then every star  $K_{1,k}$  satisfies  $\gamma_k(G) = \gamma_t(G) + k - 2$ . We will show in the next theorem that these are the only trees which satisfy this equality and for all other trees  $T$  the inequality  $\gamma_k(T) \geq \gamma_t(T) + k - 1$  is valid. We also give a characterization of those with  $\gamma_k(T) = \gamma_t(T) + k - 1$ .

Let  $\mathcal{S}_t$  be the family of trees that are obtained from a star  $K_{1,t}$  for  $t \geq 3$  by subdividing one edge twice and the remaining edges at most twice but not all edges are subdivided twice. Let  $T_t$  be the tree that is obtained from the star  $K_{1,t}$  by subdividing one edge exactly three times and let  $\mathcal{T}$  be the family of graphs that are obtained from every tree  $T \in \mathcal{S}_3 \cup \{T_3\}$  by attaching a leave to one or to both support vertices which have distance at least 2 to the unique vertex of degree 3 in  $T$ .

**Theorem 3.55** (Chellali, Favaron, Hansberg, Volkmann [16]) *Let  $T$  be a tree different from a star such that  $\Delta(T) \geq k \geq 3$  for an integer  $k$ . Then  $\gamma_k(T) \geq \gamma_t(T) + k - 1$  with equality if and only if  $T \in \mathcal{S}_k \cup \{T_k\}$  or  $T$  is isomorphic to a subdivided star  $SS_k$  minus  $r$  leaves for an integer  $0 \leq r \leq k - 1$  or  $T \in \mathcal{T}$  in the case  $k = 3$ .*

**Proof.** If  $T$  is different from a star, then it is evident that  $\gamma_c(T) \geq \gamma_t(T)$ . With Theorem 3.54, we obtain then  $\gamma_k(T) \geq \gamma_c(T) + k - 1 \geq \gamma_t(T) + k - 1$ .

*Case 1.* Suppose that  $k \geq 4$ . If  $T \in \mathcal{S}_k \cup \{T_k\}$  or  $T$  is isomorphic to a subdivided star  $SS_k$  minus  $r$  leaves for an integer  $0 \leq r \leq k - 1$ , then it is simple to verify that  $\gamma_k(T) = \gamma_t(T) + k - 1$ .

Now assume that  $\gamma_k(T) = \gamma_t(T) + k - 1$ . Then  $\gamma_k(T) = \gamma_c(T) + k - 1$  holds, too, and  $T$  is a generalized star. Additionally, regarding the proof of Theorem 3.54,  $\gamma_t(T) = \gamma_c(T) = n - \tau_1$  holds and hence  $V(T) - L$  has to be a  $\gamma_t(T)$ -set. If  $v$  is the unique vertex of degree  $k$ , then it follows that every path from  $v$  to a leaf has length at most 4, otherwise  $V(T) - L$  would not be a minimum total dominating set. Further, if there is a path of length 4 from  $v$  to a leaf, then the other neighbors of  $v$  have to be leaves, since otherwise it would again contradict the minimality of  $V(T) - L$ . Thus  $T$  is isomorphic to  $T_k$ . Assume now that every path from  $v$  has length at most 3. Then  $T$  must contain at least one path of length one or two. It is now evident that, since  $T$  is not a star,  $T$  is either isomorphic to a subdivided star,  $SS_k$  with  $k$  leaves minus  $r$  leaves or a for an integer  $0 \leq r \leq k - 1$  or  $T \in \mathcal{S}_k$ .

*Case 2.* Assume that  $k = 3$ . It is obvious that, if  $T \in \mathcal{T}$ , then  $\gamma_3(T) = \gamma_t(T) + 2$ .

Suppose now that  $\gamma_3(T) = \gamma_t(T) + 2$ . As above,  $\gamma_3(T) = \gamma_c(T) + 2$  and  $V(T) - L$  is both  $\gamma_c(T)$  and  $\gamma_t(T)$ -set. From Theorem 3.54,  $T$  is a tree with maximum degree  $\Delta(T) = 3$  such that no two vertices of degree 3 are adjacent to each other.

If  $T$  has only one vertex of degree three, then by using a same argument to that used in Case 1,  $T \in \mathcal{S}_3 \cup \{T_3\}$  or  $T$  is isomorphic to a subdivided star  $SS_3$  minus  $r$  leaves for an integer  $0 \leq r \leq 2$ . Thus we assume that  $T$  has at least two vertices of maximum degree. Now let  $H$  be the graph induced by the  $\gamma_t(T)$ -set  $V(T) - L$ . Assume for a contradiction that  $H$  contains two vertices  $x, y$  of maximum degree and all their neighbors, that is  $d_H(x) = d_H(y) = 3$ . Then, since  $H$  is connected, all vertices on the unique path between  $x$  and  $y$  have degree two in  $T$  and so  $V(T) - L$  minus any vertex adjacent to  $x$  or  $y$  on this path is a total dominating set, which is a contradiction. Thus let us assume that  $H$  contains one vertex  $u$  such that  $d_H(u) = 3$ , and let  $N_H(u) = \{u_1, u_2, u_3\}$ . Then  $d_T(u_i) = 2$  for each  $i$ . The minimality of  $H$  implies that one of  $u_1, u_2, u_3$ , say  $u_1$ , is a support vertex

in  $T$ . Since  $T$  has at least two vertices of maximum degree, we can assume that  $u_2$  has a second neighbor  $v$  in  $H$ . Again by minimality  $d_H(v) = 1$  and  $v$  is a support vertex of two leaves (since it has to be the second vertex of maximum degree). Now if  $d_H(u_3) = 1$ , then  $u_3$  is a support vertex of exactly one leaf and thus  $T \in \mathcal{T}$ . Let now  $w \neq u$  be the neighbor of  $u_3$  in  $H$ . It is clear that  $d_H(w) = 1$  and  $w$  is a support vertex of one or two leaves in  $T$ . It follows that  $T \in \mathcal{T}$ .

Assume now that  $d_H(x) \leq 2$  for every vertex in  $H$ . Since  $H$  is connected,  $H$  is a path. Assume that a vertex  $u$  of maximum degree has two neighbors in  $H$ , say  $u_1$  and  $u_2$ . Then  $u$  is a support vertex,  $d_T(u_1) = d_T(u_2) = 2$  and so, without loss of generality,  $u_1$  has another neighbor in  $H$ , say  $w$ . By the minimality of the  $\gamma_t(T)$ -set  $V(T) - L$ , it follows that  $w$  is a support vertex of two leaves and  $d_H(w) = 1$ . Now if  $d_H(u_2) = 1$ , then  $u_2$  is a support vertex of one leaf in  $T$  and  $T \in \mathcal{T}$ . Thus let  $z \neq u$  be the neighbor of  $u_2$  in  $H$ . Then  $d_H(z) = 1$  and  $z$  is a support vertex of one or two leaves in  $T$  and thus  $T \in \mathcal{T}$ .

Now we may assume that every vertex of maximum degree is a leaf in  $H$ . Let  $u$  be a vertex of maximum degree,  $v$  its unique neighbor in  $H$  and  $w \neq u$  a neighbor of  $v$  in  $H$ . If  $d_H(w) = 1$ , then  $w$  is a support vertex of two leaves in  $T$  and so  $T \in \mathcal{T}$ . Thus let  $z \neq v$  be a neighbor of  $w$  in  $H$ . Then  $d_T(w) = 2$  and, again by minimality,  $d_H(z) = 1$  and  $z$  is a support vertex of two leaves in  $T$ , which implies that  $T \in \mathcal{T}$ .

Now we have achieved every tree contained in  $\mathcal{T} \cup \{T_3\}$ , too, and the proof is complete.  $\square$

In [69], Volkmann showed that a nontrivial tree  $T$  satisfies  $\gamma_2(T) = \gamma(T) + 1$  if and only if  $T$  is a subdivided star  $SS_t$  or a subdivided star  $SS_t$  minus a leaf or a subdivided double star  $SS_{s,t}$ . As an extension to this result and as a consequence of the previous theorem, we characterize all trees  $T$  with  $\gamma_k(T) = \gamma(T) + k - 1$  for  $k \geq 3$ .

**Theorem 3.56** (Chellali, Favaron, Hansberg, Volkmann [16]) *Let  $T$  be a tree such that  $\Delta(T) \geq k \geq 3$  for an integer  $k$ . Then  $\gamma_k(T) \geq \gamma(T) + k - 1$  and  $\gamma_k(T) = \gamma(T) + k - 1$  if and only if  $T$  is isomorphic to a subdivided star  $SS_k$  minus  $r$  leaves for an integer  $1 \leq r \leq k$ .*

**Proof.** Since  $\gamma_c(T) \geq \gamma(T)$ , from Theorem 3.54 follows  $\gamma_k(T) \geq \gamma(T) + k - 1$ .

If  $T$  is isomorphic to a subdivided star  $SS_k$  minus  $r$  leaves for an integer  $1 \leq r \leq k$ , then it is easy to see that  $\gamma_k(T) = \gamma(T) + k - 1$ .

Conversely, let  $T$  be a tree with  $\gamma_k(T) = \gamma(T) + k - 1$ . Since  $\gamma_t(T) \geq \gamma(T)$ , it follows, together with the former theorem, that either  $T$  is a star or

---

$\gamma_k(G) = \gamma_t(T) + k - 1$ . If  $T$  is a star  $K_{1,t}$ , then it is easy to see that  $t = k$ . Assume now that  $T$  is not a star. Then  $T$  has to be of the form of the graphs of Theorem 3.55 satisfying  $\gamma_t(T) = \gamma(T)$ . It is now straightforward to verify that  $T$  is isomorphic to a subdivided star  $SS_k$  minus  $r$  leaves for an integer  $1 \leq r \leq k$ .  $\square$



# Chapter 4

## Other $k$ -domination parameters

In this chapter we will deal with some different  $k$ -domination parameters, where besides the property of a set of being  $k$ -dominating, we ask for some other additional properties.

### 4.1 The connected $k$ -domination number and related parameters

Let  $k$  be a positive integer. A subset  $S \subseteq V(G)$  is said to be a *total  $k$ -dominating set*, if every vertex in  $V(G)$  has at least  $k$  neighbors in  $S$  and it is a *connected  $k$ -dominating set*, if it is a  $k$ -dominating set and the graph induced by  $S$  is connected. The set  $S$  is called *connected total  $k$ -dominating set* if it is a total  $k$ -dominating set and  $G[S]$  is connected. The *total  $k$ -domination number*  $\gamma_k^t(G)$ , the *connected  $k$ -domination number*  $\gamma_k^c(G)$  and the *connected total  $k$ -domination number*  $\gamma_k^{c,t}(G)$  represent the cardinality of a minimum total  $k$ -dominating set, a minimum connected  $k$ -dominating set and, of a minimum connected total  $k$ -dominating set of  $G$ , respectively. For  $k = 1$ , we write  $\gamma_c$ ,  $\gamma_t$  and  $\gamma_{c,t}$  instead of, respectively,  $\gamma_1^c$ ,  $\gamma_1^t$  and  $\gamma_1^{c,t}$ .

Analogous to the bound of Arnaoutov, Lovász and Payan (see Corollary 2.14) for the  $k$ -domination number, Caro, West and Yuster [13] showed in 2000 that assuming  $\delta = \delta(G)$  large enough (here  $k < \sqrt{\ln \delta}$ ) the connected  $k$ -domination number is bounded by  $n \frac{\ln \delta}{\delta} (1 + o_\delta(1))$  from above. The same result was later given by Caro and Yuster [14] for  $(F, k)$ -cores, which is a more general concept for connected total  $k$ -dominating sets.

In [71], Volkmann continued the study of the connected  $k$ -domination. In particular, he presented two bounds closely related to Theorems 1.3 and 1.4 by Fink and Jacobson [27].

Similar to the bound  $\gamma_k(G) \geq \gamma(G) + k - 2$  for graphs  $G$  with  $2 \leq k \leq$

$\Delta(G)$  given by Fink and Jacobson in [27] (Theorem 2.17), we present the following bound for the connected case.

**Theorem 4.1** (Hansberg [33]) *Let  $G$  be a connected graph and  $k$  an integer with  $2 \leq k \leq \delta(G)$ . Then*

$$\gamma_k^c(G) \geq \gamma_c(G) + k - 2.$$

**Proof.** Let  $D$  be a minimum connected  $k$ -dominating set of  $G$ . Since  $\delta(G) \geq k$ ,  $V - D$  is not empty. Let  $u \in V - D$  and let  $T$  be a spanning tree of the connected graph  $G' = G[D \cup \{u\}]$  such that  $uv \in E(T)$  for all  $v \in N_G(u) \cap D$ . Since  $d_{G'}(u) \geq k$ , the tree  $T$  has at least  $k$  leaves  $u_1, u_2, \dots, u_k$ . Then  $T - \{u_1, u_2, \dots, u_{k-1}\}$  is connected and every vertex in  $(V - D) \cup \{u_1, u_2, \dots, u_{k-1}\}$  has at least one neighbor in  $D' = (D \cup \{u\}) - \{u_1, u_2, \dots, u_{k-1}\}$ . Hence,  $D'$  is a connected dominating set of  $G$  and it follows

$$\gamma_c(G) \leq \gamma_k^c(G) - k + 2,$$

which completes the proof.  $\square$

Note that in the connected case the assumption  $k \geq \Delta(G)$  is not sufficient for guaranteeing the non-emptiness of  $V - D$ , as can be seen for example in the graph  $K_{1,r}$  for  $r \geq k$ .

In [71], Volkmann proved also the following theorem.

**Theorem 4.2** (Volkmann [71], 2009) *If  $G$  is a connected nontrivial graph, then  $\gamma_2^c(G) \geq \gamma_c(G) + 1$  and  $\gamma_3^c(G) \geq \gamma_c(G) + 2$*

He also gave examples of graphs  $G$  with  $\gamma_k^c(G) = \gamma_c(G) + k - 2$  for  $k \geq 4$ . Thus, the inequality of Theorem 4.1 is sharp for  $k \geq 4$ . For the case that  $k = 2$  and graphs with cut vertices, we present the following bound, which improves in some manner the bound of Volkmann. Hereby, we denote with  $\kappa_{\max}(G)$  the maximum number of components of  $G - u$  among all vertices  $u \in V$ .

**Theorem 4.3** (Hansberg [33]) *Let  $G$  be a connected graph on  $n \geq 2$  vertices. If  $G$  has a cut vertex, then*

$$\gamma_2^c(G) \geq \gamma_c(G) + \kappa_{\max}(G).$$

**Proof.** Let  $D$  be a minimum connected 2-dominating set of  $G$ . Since  $G$  has a cut vertex,  $\kappa = \kappa_{\max}(G) \geq 2$ . Let  $u \in V$  such that  $G - u$  has  $\kappa$  components  $G_1, G_2, \dots, G_\kappa$ . Since  $u$  is a cut vertex, it is evident that  $u \in D$ . Let  $v_i \in D \cap V(G_i)$  be a leaf of a spanning tree of  $G[D]$  for each  $1 \leq i \leq \kappa$  and define  $U = \{v_1, v_2, \dots, v_\kappa\}$ . Then the graph  $G[D - U]$  is connected. Moreover, every vertex in  $(V - D) \cup U$  has at least one neighbor in  $D - U$ . This implies that  $D - U$  is a connected dominating set of  $G$  and hence  $\gamma_c(G) \leq \gamma_2^c(G) - \kappa_{\max}(G)$ .  $\square$

Volkman's inequality  $\gamma_2^c \geq \gamma_c + 1$  of Theorem 4.2 together with Theorem 4.3 imply the following corollary.

**Corollary 4.4** (Hansberg [33]) *If  $G$  is a connected nontrivial graph, then*

$$\gamma_2^c(G) \geq \gamma_c(G) + \kappa_{\max}(G).$$

Easily, following corollaries are derived from this statement.

**Corollary 4.5** (Hansberg [33]) *If  $G$  is a graph with  $\gamma_2^c(G) = \gamma_c(G) + q$ , then  $\kappa_{\max}(G) \leq q$ .*

**Corollary 4.6** (Hansberg [33]) *If  $G$  is a graph with  $\gamma_2^c(G) = \gamma_c(G) + 1$ , then  $G$  contains no cut vertices.*

**Corollary 4.7** (Hansberg [33]) *Let  $G$  be a block-cactus graph. Then  $\gamma_2^c(G) = \gamma_c(G) + 1$  if and only if  $G$  is either a complete graph  $K_n$  of order  $n \geq 2$  or a cycle  $C_n$  of length  $n \geq 3$ .*

**Example 4.8** (Hansberg [33]) *Let  $H$  be the graph that consists of  $r \geq 2$  different graphs  $H_i \cong K_{q_i}$  for integers  $q_i \geq 2$ ,  $1 \leq i \leq r$ , an additional vertex  $x$  joining the  $H_i$ 's each by an edge and a leaf  $x_i$  attached to a vertex of degree  $q_i - 1$  in  $H_i$  for  $1 \leq i \leq r$ . Then  $\gamma_c(H) = 2r + 1$ ,  $\gamma_2(H) = 3r + 1$  and  $\kappa_{\max}(H) = r$  and thus the inequality of Theorem 4.3 is sharp.*

The bound of Theorem 4.1 can be improved the following way.

**Theorem 4.9** (Hansberg [33]) *Let  $G$  be a connected graph and  $k$  an integer with  $2 \leq k \leq \delta(G)$ . Then*

$$\gamma_k^c(G) \geq \gamma_c(G) + (k - 2)\kappa_{\max}(G).$$

**Proof.** If  $\kappa_{\max}(G) = 1$ , Theorem 4.1 yields the desired result. Thus, suppose that  $\kappa = \kappa_{\max}(G) \geq 2$ . Let  $u$  be a vertex of  $G$  such that  $G - u$  has  $\kappa$  components  $G_1, G_2, \dots, G_\kappa$ . Let  $D$  be a minimum connected  $k$ -dominating set of  $G$  and define  $D_i = V(G_i) \cap D$  for each  $1 \leq i \leq \kappa$ . Because  $u$  is a cut vertex,  $u \in D$ . Since  $\delta(G) \geq k$ ,  $V(G_i) - D_i \neq \emptyset$ . Let  $x_i \in V(G_i) - D_i$ ,  $1 \leq i \leq \kappa$ . Then  $x_i$  has at least  $k$  neighbors in  $D_i \cup \{u\}$  and there is a spanning tree  $T_i$  of  $G[D_i \cup \{u, x_i\}]$  containing  $x_i$  and all edges  $x_i y$ , where  $y \in (D_i \cup \{u\}) \cap N(x_i)$ . Evidently,  $T_i$  has at least  $k$  leaves (where  $u$  is also possible). For each  $1 \leq i \leq \kappa$ , let  $U_i$  be a set of  $k - 1$  leaves of  $T_i$  such that they are all different from  $u$ , and define  $U = \bigcup_{i=1}^{\kappa} U_i$ . Then  $D' = (D - U) \cup \{x_1, x_2, \dots, x_\kappa\}$  is a connected dominating set and hence

$$\gamma_c(G) \leq \gamma_k^c(G) - \kappa(k - 1) + \kappa = \gamma_k^c(G) - (k - 2)\kappa_{\max}(G).$$

□

For graphs containing cut vertices, where obviously  $\kappa_{\max}(G) \geq 2$  holds, we gain the next corollary.

**Corollary 4.10** (Hansberg [33]) *Let  $G$  be a connected graph and  $k$  an integer with  $2 \leq k \leq \delta(G)$ . If  $G$  has a cut vertex, then*

$$\gamma_k^c(G) \geq \gamma_c(G) + 2(k - 2).$$

**Theorem 4.11** (Hansberg [33]) *Let  $G$  be a connected graph on  $n$  vertices with minimum degree  $\delta \geq 2$  and let  $k$  be an integer with  $1 \leq k \leq \delta$ . Then*

$$\gamma_k^c(G) \leq n - \kappa_{\max}(G)(\delta - k + 1).$$

**Proof.** If  $G$  is the trivial graph, then  $\kappa_{\max}(G) = 0$  and the statement is immediate. Thus assume that  $\delta \geq 1$ . Let  $u$  be a vertex of  $G$  such that  $G - u$  has  $\kappa = \kappa_{\max}(G)$  components  $G_1, G_2, \dots, G_\kappa$ . For each  $1 \leq i \leq \kappa$ , let  $u_i \in V(G_i)$  be a neighbor of  $u$  and let  $H_i = G[V(G_i) \cup \{u\}]$ . Then  $d_{H_i}(u_i) \geq \delta \geq 1$ . For each  $1 \leq i \leq \kappa$ , let  $T_i$  be a spanning tree of  $H_i$  containing  $u_i$  and all edges  $u_i x$ , where  $x \in V(H_i) \cap N(u_i)$ . Then  $T_i$  has at least  $\max\{\delta, 2\}$  leaves, where  $u$  is also possible. Let  $L_i \subseteq V(G_i)$  be a set of exactly  $\delta - k + 1 \geq 1$  leaves of  $T_i$  (i.e. all different from  $u$ ), for  $1 \leq i \leq \kappa$ , and let  $L = \bigcup_{i=1}^{\kappa} L_i$ . Evidently  $G[V - L]$  is connected. Moreover, if  $x \in L_i$ , then  $|N(x) \cap (V - L)| = |N(x) \cap (V - L_i)| \geq \delta - |L_i - \{x\}| \geq k$ . Hence,  $V - L$  is a connected  $k$ -dominating set of  $G$  and thus

$$\gamma_k^c(G) \leq n - \kappa_{\max}(G)(\delta - k + 1).$$

□

As a consequence, following proposition of Volkmann follows.

**Corollary 4.12** (Volkman [71], 2009) *Let  $k$  and  $r$  be two integers such that  $k \geq 1$  and  $r \geq 0$ . If  $G$  is a connected graph of order  $n$  and minimum degree  $\delta \geq k + r$ , then*

$$\gamma_k^c(G) \leq n - r - 1.$$

Again, for graphs containing cut vertices, we obtain a corollary.

**Corollary 4.13** (Hansberg [33]) *Let  $G$  be a connected graph on  $n$  vertices and minimum degree  $\delta$  and let  $k$  be an integer with  $1 \leq k \leq \delta$ . If  $G$  has a cut vertex, then*

$$\gamma_k^c(G) \leq n - 2(\delta - k + 1).$$

**Example 4.14** (Hansberg [33]) *Let  $p$ ,  $r$  and  $k$  be integers such that  $p \geq k + 1 \geq 2$  and  $r \geq \max\{p - 1, 2\}$ . Let  $G$  be the graph consisting of a vertex  $u$  and  $r$  copies of a  $K_p$  joined each to the vertex  $u$  by an edge. Then  $\kappa_{\max}(G) = r$ ,  $\delta(G) = p - 1$ ,  $\gamma_k^c(G) = kr + 1 = (pr + 1) - r(p - k) = n - \kappa_{\max}(G)(\delta - k + 1)$ . Thus the inequality in Theorem 4.11 is sharp.*

The following two theorems are proved using the method described in [35].

**Theorem 4.15** (Hansberg [33]) *Let  $G$  be a connected graph and  $k$  an integer with  $2 \leq k \leq \Delta(G)$ . Then*

$$\gamma_k^c(G) \leq 2\gamma_k(G) - k + 1.$$

**Proof.** Let  $D$  be a minimum  $k$ -dominating set and let  $x \in V - D$ . Note that  $V - D$  is not empty since  $\Delta(G) \geq k$ . If  $G[D \cup \{x\}]$  is connected, then  $\gamma_k^c(G) \leq \gamma_k(G) + 1 \leq 2\gamma_k(G) - k + 1$ . Thus, we assume that  $G[D \cup \{x\}]$  is not connected. We will add vertices successively from  $V - (D \cup \{x\})$  to  $D \cup \{x\}$  in order to decrease the number of components of  $G[D \cup \{x\}]$  at least by one in each step, until we obtain a set whose induced graph is connected. Note that if we partition  $D \cup \{x\}$  into parts  $A$ ,  $B$  such that  $A$  and  $B$  have no edges connecting them and we take vertices  $a \in A$  and  $b \in B$  such that the distance between  $a$  and  $b$  is minimum, then the property of  $D$  of being dominating implies that  $d(a, b) \leq 3$ . Thus, in each step of increasing  $D$  we need to add at most 2 vertices from  $V - (D \cup \{x\})$ . Let  $r_1$  and  $r_2$  be the number of steps where we include one vertex and two vertices from  $V - (D \cup \{x\})$ , respectively, and let  $r = r_1 + r_2$ . Let  $D_0 \subset D \cup \{x\}$  be the set of vertices of the component of  $G[D \cup \{x\}]$  to which  $x$  belongs and let  $D_i \subset D$  be the set of vertices connected to  $\bigcup_{j=0}^{i-1} D_j$  in step  $i$ . Obviously  $|D_0| \geq k + 1$  and  $|D_i| \geq 1$  for  $1 \leq i \leq r$ . Moreover, since  $D$  is a  $k$ -dominating set, in the steps

where two vertices from  $V - (D \cup \{x\})$  are added we even have that  $|D_i| \geq k$ . Thus we obtain

$$\gamma_k(G) = |D| = |D_0 - \{x\}| + \sum_{i=1}^r |D_i| \geq k(1 + r_2) + r_1$$

and thus  $r_1 \leq \gamma_k(G) - (r_2 + 1)k$ . Further,  $D \cup \{x\}$  together with all vertices from  $V - (D \cup \{x\})$  added in steps 1 to  $r$  form a connected  $k$ -dominating set. Hence, since  $k \geq 2$ ,

$$\begin{aligned} \gamma_k^c(G) &\leq |D| + 1 + r_1 + 2r_2 \leq \gamma_k(G) + 1 + \gamma_k(G) - (r_2 + 1)k + 2r_2 \\ &= 2\gamma_k(G) - k + 1 - r_2(k - 2) \leq 2\gamma_k(G) - k + 1 \end{aligned}$$

and we are done.  $\square$

Regarding the graph  $K_{k,p}$  for an integer  $p \geq 1$ , one can see that the bound in this theorem is sharp.

In 1981, Duchet and Meyniel [22] proved that  $\gamma_c(G) \leq 3\gamma(G) - 2$ . In [14], Caro and Yuster presented an analogous bound involving the total and the connected total  $k$ -domination numbers, which they used for proving the probabilistic approach mentioned in the beginning of the section for the minimum cardinality of an  $(F, k)$ -core.

**Lemma 4.16** (Caro, West, Yuster [13], 2000) *If  $G$  is a connected graph, then*

$$\gamma_k^t(G) \leq \gamma_k^{c,t}(G) \leq 3\gamma_k^t(G) - 2.$$

The next theorem improves this bound considerably.

**Theorem 4.17** (Hansberg [33]) *Let  $G$  be a connected graph and  $k \geq 1$  an integer. Then*

$$\max\{\gamma_k^c(G), \gamma_k^t(G)\} \leq \gamma_k^{c,t}(G) \leq \frac{k+3}{k+1}\gamma_k^t(G) - 2.$$

**Proof.** Let  $D$  be a minimum total  $k$ -dominating set. If  $G[D]$  is connected, then the upper bound is trivial. Thus suppose that  $G[D]$  is not connected. We will add vertices successively from  $V - D$  to  $D$  in order to decrease the number of components of  $G[D]$  at least one in each step, until we obtain a set whose induced graph is connected. Note that if we partition  $D$  into parts  $A, B$  such that  $A$  and  $B$  have no edges connecting them and we take vertices  $a \in A$  and  $b \in B$  such that the distance between  $a$  and  $b$  is minimum, then

the property of  $D$  of being dominating implies that  $d(a, b) \leq 3$ . Thus, in each step of increasing  $D$  we need to add at most 2 vertices from  $V - D$ . Let  $r_1$  be the number of steps where we include exactly one vertex and let  $r$  be the total number of steps required in the whole process. Since  $D$  is a total  $k$ -dominating set, every component of  $G[D]$  is of order at least  $k + 1$ . Thus

$$r \leq \frac{\gamma_k^t(G)}{k + 1} - 1.$$

On the other side, let  $S_i \subseteq V - D$  be the set of one or two vertices included in step  $i$ . Then  $D \cup \bigcup_{i=1}^r S_i$  is a connected total  $k$ -dominating set and hence

$$\begin{aligned} \gamma_k^{c,t}(G) &\leq |D| + \sum_{i=1}^r |S_i| = \gamma_k^t(G) + 2r - r_1 \\ &\leq \gamma_k^t(G) + 2\frac{\gamma_k^t(G)}{k + 1} - 2 - r_1 = \frac{k + 3}{k + 1}\gamma_k^t(G) - 2 - r_1 \\ &\leq \frac{k + 3}{k + 1}\gamma_k^t(G) - 2 \end{aligned}$$

Since the inequalities  $\gamma_k^c(G) \leq \gamma_k^{c,t}(G)$  and  $\gamma_k^t(G) \leq \gamma_k^{c,t}(G)$  are trivial, the proof is complete.  $\square$

For  $k = 1$ , we obtain a result of Favaron and Kratsch [26].

**Corollary 4.18** (Favaron, Kratsch [26], 1991) *If  $G$  is a connected nontrivial graph, then*

$$\gamma_c(G) \leq 2(\gamma_t(G) - 1).$$

**Example 4.19** (Hansberg [33]) *Let  $G_1$  and  $G_2$  be two graphs with vertex sets  $V(G_i) = A_i \cup B_i$ ,  $i = 1, 2$ , such that  $G_i[A_i] \cong K_{k+1}$  and  $B_i$  is an independent set of vertices of degree  $k$  and suppose that  $N_{G_i}(B_i) = A_i$  and  $|B_i| \geq 2$ . Let  $G$  be the union of  $G_1$  and  $G_2$  joined by an arbitrary matching between vertices of  $B_1$  and  $B_2$ . Then*

$$\frac{k + 3}{k + 1}\gamma_k^t(G) - 2 = \frac{k + 3}{k + 1}2(k + 1) - 2 = 2(k + 3) - 2 = 2(k + 1) = \gamma_k^{c,t}(G).$$

Hence, the bound of Theorem 4.17 is sharp.

## 4.2 The Roman $k$ -domination number

A Roman  $k$ -dominating function on  $G$  is a function  $f : V(G) \rightarrow \{0, 1, 2\}$  such that every vertex  $u$  for which  $f(u) = 0$  is adjacent to at least  $k$  vertices

$v_1, v_2, \dots, v_k$  with  $f(v_i) = 2$  for  $i = 1, 2, \dots, k$ . The *weight* of a Roman  $k$ -dominating function is the value  $f(V(G)) = \sum_{v \in V(G)} f(v)$ . The minimum weight of a Roman  $k$ -dominating function on a graph  $G$  is called the *Roman  $k$ -domination number*  $\gamma_{kR}(G)$ . If  $f : V(G) \rightarrow \{0, 1, 2\}$  is a Roman  $k$ -dominating function on  $G$ , then let  $(V_0, V_1, V_2)$  be the ordered partition of  $V(G)$  induced by  $f$ , where  $V_i = \{v \in V(G) \mid f(v) = i\}$  for  $i = 0, 1, 2$ . Note that there is a one to one correspondence between the functions  $f : V(G) \rightarrow \{0, 1, 2\}$  and the ordered partitions  $(V_0, V_1, V_2)$  of  $V(G)$ . The Roman 1-domination number  $\gamma_{1R}$  corresponds to the well-known *Roman domination number*  $\gamma_R$ , which was given implicitly by Steward in [65] and by ReVelle and Rosing in [63]. We present now the following bounds, which are proved using the probabilistic method like for the  $k$ -domination number in Theorem 2.12.

**Theorem 4.20** (Hansberg, Volkmann [41], 2009) *Let  $G$  be a graph on  $n$  vertices with minimum degree  $\delta \geq 1$  and let  $k \in \mathbb{N}$ . If  $\frac{\delta+1+2\ln(2)}{\ln(\delta+1)} \geq 2k$  then*

$$\gamma_{kR}(G) \leq \frac{2n}{\delta+1} \left( k \ln(\delta+1) - \ln(2) + \sum_{i=0}^{k-1} \frac{1}{i!} \frac{\delta^i}{(\delta+1)^{k-1}} \right).$$

**Proof.** Let  $2k \leq \frac{\delta+1+2\ln(2)}{\ln(\delta+1)}$  and define  $p = \frac{k \ln(\delta+1) - \ln(2)}{\delta+1}$ . The condition on  $\delta$  implies that  $p \leq \frac{1}{2}$ . We select a set of vertices  $A \subseteq V(G)$  independently at random with  $P(v \in A) = p$ . Let  $B$  be the set of vertices of  $V(G) - A$  with less than  $k$  neighbors in  $A$ . Then  $A \cup B$  is a  $k$ -dominating set of  $G$  and  $f = (V(G) - (A \cup B), B, A)$  is a  $k$ -roman domination function for  $G$ . As in the proof of Theorem 2.12, we have

$$P(v \in B) \leq \sum_{i=0}^{k-1} \frac{1}{i!} e^{-p(\delta+1)+i \ln(\delta)}.$$

Thus, we obtain in this case

$$P(v \in B) \leq \sum_{i=0}^{k-1} \frac{1}{i!} e^{-k \ln(\delta+1) + \ln(2) + i \ln(\delta)} = \sum_{i=0}^{k-1} \frac{2 \delta^i}{i! (\delta+1)^k}.$$

This implies

$$\begin{aligned} \gamma_{kR}(G) &\leq E[f(V(G))] = E[|A|] + 2E[|B|] \\ &\leq 2n \left( \frac{k \ln(\delta+1) - \ln(2)}{\delta+1} \right) + n \sum_{i=0}^{k-1} \frac{2 \delta^i}{i! (\delta+1)^k} \\ &= \frac{2n}{\delta+1} \left( k \ln(\delta+1) - \ln(2) + \sum_{i=0}^{k-1} \frac{\delta^i}{i! (\delta+1)^{k-1}} \right). \end{aligned}$$

□

**Corollary 4.21** (Hansberg, Volkmann [41], 2009) *Let  $G$  be a graph on  $n$  vertices with minimum degree  $\delta \geq k$ , where  $k \in \mathbb{N}$ . If  $\frac{\delta+1+2\ln(2)}{\ln(\delta+1)} \geq 2k$ , then*

$$\gamma_{kR}(G) \leq \frac{2n}{\delta+1}(k \ln(\delta+1) - \ln(2) + 1).$$

**Proof.** As in the proof of Corollary 2.13, Theorem 4.20 and the fact that  $\sum_{i=0}^{k-1} \delta^i \leq (\delta+1)^{k-1}$  imply

$$\begin{aligned} \gamma_{kR}(G) &\leq \frac{2n}{\delta+1} \left( k \ln(\delta+1) - \ln(2) + \sum_{i=0}^{k-1} \frac{1}{i!} \frac{\delta^i}{(\delta+1)^{k-1}} \right) \\ &\leq \frac{2n}{\delta+1} (k \ln(\delta+1) - \ln(2) + 1). \end{aligned}$$

□

Setting  $k = 1$ , we obtain the following bound for the usual Roman domination number  $\gamma_R$ . Note that this should be the same bound computed by Cockayne, Dreyer, Hedetniemi and Hedetniemi in [19] if we consider the error that was made in that paper forgetting a factor 2 in their computation. Moreover, the condition  $\delta \geq 1$  cannot be avoided, otherwise the chosen probability  $p$  of the above theorem, which is also the same for  $k = 1$  as in [19], would be negative. Hence, the theorem given by the former authors, should be like follows.

**Corollary 4.22** (Cockayne, Dreyer, Hedetniemi, Hedetniemi [19], 2004, 2009) *Let  $G$  be a graph on  $n$  vertices with minimum degree  $\delta \geq 1$ . Then*

$$\gamma_R(G) \leq \frac{2n}{\delta+1} (\ln(\delta+1) - \ln(2) + 1).$$

The following observation shows that, for  $k \geq 3$ , Corollary 4.21 can be improved.

**Observation 4.23** (Hansberg, Volkmann [41], 2009) *Let  $k \geq 4$  be an integer and  $G$  a graph of minimum degree  $\delta \geq k$ . If  $\frac{\delta+1+2\ln(2)}{\ln(\delta+1)} \geq 2k$ , then*

$$\gamma_{kR}(G) \leq \frac{2n}{\delta+1} \left( k \ln(\delta+1) - \ln(2) + 1 - \frac{k-1}{\delta} \right).$$

**Proof.** In view Theorem 4.20, we only have to show that, for  $k \geq 4$ ,

$$\sum_{i=0}^{k-1} \frac{\delta^i}{i! (\delta + 1)^{k-1}} \leq 1 - \frac{k-1}{\delta}.$$

Since this was already shown in Observation 2.16, we are done.  $\square$

Note that for  $k = 3$ , instead of the term  $\frac{k-1}{\delta}$  of previous observation, we can set everywhere the term  $\frac{k-2}{\delta}$  and we obtain for this case a better result as in Corollary 4.21, too.

# Bibliography

- [1] Robert B. Allan and Renu Laskar, *On domination and independent domination numbers of a graph*, Discrete Math. **23** (1978), no. 2, 73–76.
- [2] Noga Alon and Joel H. Spencer, *The Probabilistic Method*, second ed., Wiley-Interscience Series in Discrete Mathematics and Optimization, Wiley-Interscience [John Wiley & Sons], New York, 2000, With an appendix on the life and work of Paul Erdős.
- [3] Vladimir I. Arnautov, *Estimation of the exterior stability number of a graph by means of the minimal degree of the vertices*, Prikl. Mat. i Programirovanie **11** (1974), 3–8, 126.
- [4] Lowell W. Beineke, *Derived graphs and digraphs*, Beiträge zur Graphentheorie, Teubner, Leipzig, 1968.
- [5] Claude Berge, *Graphs and Hypergraphs*, North-Holland Publishing Co., Amsterdam, 1973, Translated from the French by Edward Minieka, North-Holland Mathematical Library, Vol. 6.
- [6] Mostafa Blidia, Mustapha Chellali, and Odile Favaron, *Independence and 2-domination in trees*, Australas. J. Combin. **33** (2005), 317–327.
- [7] Mostafa Blidia, Mustapha Chellali, and Lutz Volkmann, *Bounds of the 2-domination number of graphs*, Util. Math. **71** (2006), 209–216.
- [8] ———, *Some bounds on the  $p$ -domination number in trees*, Discrete Math. **306** (2006), no. 17, 2031–2037.
- [9] Béla Bollobás and Ernie J. Cockayne, *Graph-theoretic parameters concerning domination, independence, and irredundance*, J. Graph Theory **3** (1979), no. 3, 241–249.
- [10] R. L. Brooks, *On colouring the nodes of a network*, Proc. Cambridge Philos. Soc. **37** (1941), 194–197.

- 
- [11] Yair Caro, *On the  $k$ -domination and  $k$ -transversal numbers of graphs and hypergraphs*, Ars Combin. **29** (1990), no. C, 49–55, Twelfth British Combinatorial Conference (Norwich, 1989).
- [12] Yair Caro and Yehuda Roditty, *A note on the  $k$ -domination number of a graph*, Internat. J. Math. Math. Sci. **13** (1990), no. 1, 205–206.
- [13] Yair Caro, Douglas B. West, and Raphael Yuster, *Connected domination and spanning trees with many leaves*, SIAM J. Discrete Math. **13** (2000), no. 2, 202–211 (electronic).
- [14] Yair Caro and Raphael Yuster, *Dominating a family of graphs with small connected subgraphs*, Combin. Probab. Comput. **9** (2000), no. 4, 309–313.
- [15] Mustapha Chellali and Odile Favaron, *On  $k$ -star forming sets in graphs*, J. Combin. Math. Combin. Comput. (to appear).
- [16] Mustapha Chellali, Odile Favaron, Adriana Hansberg, and Lutz Volkmann, *On the  $p$ -domination, the total domination and the connected domination numbers of graphs*, J. Combin. Math. Combin. Comput. (to appear).
- [17] Beifang Chen and Sanming Zhou, *Upper bounds for  $f$ -domination number of graphs*, Discrete Math. **185** (1998), no. 1-3, 239–243.
- [18] Guantao Chen and Michael S. Jacobson, *On a relationship between 2-dominating and 5-dominating sets in graphs*, J. Combin. Math. Combin. Comput. **39** (2001), 139–145.
- [19] Ernie J. Cockayne, Paul A. Dreyer, Jr., Sandra M. Hedetniemi, and Stephen T. Hedetniemi, *Roman domination in graphs*, Discrete Math. **278** (2004), no. 1-3, 11–22.
- [20] Ernie J. Cockayne, B. Gamble, and Bruce Shepherd, *An upper bound for the  $k$ -domination number of a graph*, J. Graph Theory **9** (1985), no. 4, 533–534.
- [21] Ernie J. Cockayne, Teresa W. Haynes, Stephen T. Hedetniemi, Baogen Xu, and Zhou Shangchao, *Extremal graphs for inequalities involving domination parameters*, Discrete Math. **216** (2000), no. 1-3, 1–10.
- [22] Pierre Duchet and Henry Meyniel, *On Hadwiger's number and the stability number*, Graph theory (Cambridge, 1981), North-Holland Math. Stud., vol. 62, North-Holland, Amsterdam, 1982, pp. 71–73.

- 
- [23] Odile Favaron, *On a conjecture of Fink and Jacobson concerning  $k$ -domination and  $k$ -dependence*, J. Combin. Theory Ser. B **39** (1985), no. 1, 101–102.
- [24] ———,  *$k$ -domination and  $k$ -independence in graphs*, Ars Combin. **25** (1988), no. C, 159–167, Eleventh British Combinatorial Conference (London, 1987).
- [25] Odile Favaron, Adriana Hansberg, and Lutz Volkmann, *On  $k$ -domination and minimum degree in graphs*, J. Graph Theory **57** (2008), no. 1, 33–40.
- [26] Odile Favaron and Dieter Kratsch, *Ratios of domination parameters*, Advances in graph theory, Vishwa, Gulbarga, 1991, pp. 173–182.
- [27] John Frederick Fink and Michael S. Jacobson,  *$n$ -domination in graphs*, Graph theory with applications to algorithms and computer science (Kalamazoo, Mich., 1984), Wiley-Intersci. Publ., Wiley, New York, 1985, pp. 283–300.
- [28] ———, *On  $n$ -domination,  $n$ -dependence and forbidden subgraphs*, Graph theory with applications to algorithms and computer science (Kalamazoo, Mich., 1984), Wiley-Intersci. Publ., Wiley, New York, 1985, pp. 301–311.
- [29] John Frederick Fink, Michael S. Jacobson, Lael F. Kinch, and John Roberts, *On graphs having domination number half their order*, Period. Math. Hungar. **16** (1985), no. 4, 287–293.
- [30] Jun Fujisawa, Adriana Hansberg, Takahiro Kubo, Akira Saito, Masahide Sugita, and Lutz Volkmann, *Independence and 2-domination in bipartite graphs*, Australas. J. Combin. **40** (2008), 265–268.
- [31] Michael R. Garey and David S. Johnson, *Computers and intractability*, W. H. Freeman and Co., San Francisco, Calif., 1979, A guide to the theory of NP-completeness, A Series of Books in the Mathematical Sciences.
- [32] Alan Gibbons, *Algorithmic Graph Theory*, Cambridge University Press, Cambridge, 1985.
- [33] Adriana Hansberg, *Bounds on the connected  $k$ -domination number in graphs*, submitted.

- 
- [34] ———, *On the  $p$ -domination number, the domination number and the cycle of length four*, submitted.
- [35] Adriana Hansberg, Dirk Meierling, and Lutz Volkmann, *A general method in the theory of domination in graphs*, Int. J. Comput. Math. (to appear).
- [36] ———, *Independence and  $p$ -domination in graphs*, submitted.
- [37] Adriana Hansberg and Lutz Volkmann, *Characterization of block graphs with equal 2-domination number and domination number plus one*, Discuss. Math. Graph Theory **27** (2007), no. 1, 93–103.
- [38] ———, *Characterization of unicyclic graphs with equal 2-domination number and domination number plus one*, Util. Mat. **77** (2008), 265–276.
- [39] ———, *On graphs with equal domination and 2-domination numbers*, Discrete Math. **308** (2008), no. 11, 2277–2281.
- [40] ———, *Lower bounds on the  $p$ -domination number in terms of cycles and matching number*, J. Combin. Math. Combin. Comput **68** (2009), 245–255.
- [41] ———, *Upper bounds on the  $k$ -domination number and the  $k$ -Roman domination number*, Discrete Appl. Math. **157** (2009), no. 7, 1634–1639.
- [42] ———, *On 2-domination and independent domination numbers in graphs*, Ars Combin. (to appear).
- [43] Teresa W. Haynes, Stephen T. Hedetniemi, and Peter J. Slater, *Fundamentals of domination in graphs*, Monographs and Textbooks in Pure and Applied Mathematics, vol. 208, Marcel Dekker Inc., New York, 1998.
- [44] ———, *Domination in graphs: Advanced topics*, Monographs and Textbooks in Pure and Applied Mathematics, vol. 209, Marcel Dekker Inc., New York, 1998.
- [45] Sandra Hedetniemi, Stephen Hedetniemi, and Renu Laskar, *Domination in trees: models and algorithms*, Graph theory with applications to algorithms and computer science (Kalamazoo, Mich., 1984), Wiley-Intersci. Publ., Wiley, New York, 1985, pp. 423–442.
- [46] Angelika Hellwig and Lutz Volkmann, *Some upper bounds for the domination number*, J. Combin. Math. Combin. Comput. **57** (2006), 187–209.

- 
- [47] Glenn Hopkins and William Staton, *Vertex partitions and  $k$ -small subsets of graphs*, *Ars Combin.* **22** (1986), 19–24.
- [48] Michael S. Jacobson and Ken Peters, *Complexity questions for  $n$ -domination and related parameters*, *Congr. Numer.* **68** (1989), 7–22, Eighteenth Manitoba Conference on Numerical Mathematics and Computing (Winnipeg, MB, 1988).
- [49] Michael S. Jacobson, Kenneth Peters, and Douglas F. Rall, *On  $n$ -irredundance and  $n$ -domination*, *Ars Combin.* **29** (1990), no. B, 151–160, Twelfth British Combinatorial Conference (Norwich, 1989).
- [50] Dénes König, *Graphen und Matrizen*, *Mat. Fiz. Lapok* **38** (1931), 116–119 (Hungarian).
- [51] J. Krausz, *Démonstration nouvelle d’une théorème de Whitney sur les réseaux*, *Mat. Fiz. Lapok* **50** (1943), 75–85.
- [52] László Lovász, *On the ratio of optimal integral and fractional covers*, *Discrete Math.* **13** (1975), no. 4, 383–390.
- [53] William McCuaig and Bruce Shepherd, *Domination in graphs with minimum degree two*, *J. Graph Theory* **13** (1989), no. 6, 749–762.
- [54] S. Nünning, *Abschätzungen der Dominanzzahl*, Diploma Thesis (supervised by L. Volkmann and D. Rautenbach), 2000.
- [55] Oystein Ore, *Theory of graphs*, American Mathematical Society Colloquium Publications, Vol. XXXVIII, American Mathematical Society, Providence, R.I., 1962.
- [56] Patric R. J. Östergård and William D. Weakley, *Values of domination numbers of the queen’s graph*, *Electron. J. Combin.* **8** (2001), no. 1, Research Paper 29, 19 pp. (electronic).
- [57] Charles Payan, *Sur le nombre d’absorption d’un graphe simple*, *Cahiers Centre Études Recherche Opér.* **17** (1975), no. 2-4, 307–317, Colloque sur la Théorie des Graphes (Paris, 1974).
- [58] Charles Payan and Nguyen Huy Xuong, *Domination-balanced graphs*, *J. Graph Theory* **6** (1982), 23–32.
- [59] Bert Randerath and Lutz Volkmann, *Characterization of graphs with equal domination and covering number*, *Discrete Math.* **191** (1998), no. 1-3, 159–169, *Graph theory* (Elgersburg, 1996).

- [60] ———, *Characterization of graphs with equal domination and matching number*, Util. Math. **55** (1999), 65–72.
- [61] Dieter Rautenbach and Lutz Volkmann, *New bounds on the  $k$ -domination number and the  $k$ -tuple domination number*, Appl. Math. Lett. **20** (2007), no. 1, 98–102.
- [62] Bruce Reed, *Paths, stars and the number three*, Combin. Probab. Comput. **5** (1996), no. 3, 277–295.
- [63] Charles S. ReVelle and Kenneth E. Rosing, *Defendens Imperium Romanum: a classical problem in military strategy*, Amer. Math. Monthly **107** (2000), no. 7, 585–594.
- [64] MooYoung Sohn and Xudong Yuan, *Domination in graphs of minimum degree four*, The China-Japan Joint Conference on Discrete Geometry, Combinatorics and Graph Theory (2005).
- [65] Ian Steward, *Defend the Roman Empire!*, Sci. Amer. **281** (1999), 136–139.
- [66] Christoph Stracke and Lutz Volkmann, *A new domination conception*, J. Graph Theory **17** (1993), no. 3, 315–323.
- [67] Lutz Volkmann, *Simple reduction theorems for finding minimum coverings and minimum dominating sets*, Contemporary methods in graph theory, Bibliographisches Inst., Mannheim, 1990, pp. 667–672.
- [68] ———, *Graphen an allen Ecken und Kanten*, RWTH Aachen, [http://www.math2.rwth-aachen.de/~uebung/de/lehre/ss08/graphen\\_an\\_allen\\_ecken\\_und\\_kanten.pdf](http://www.math2.rwth-aachen.de/~uebung/de/lehre/ss08/graphen_an_allen_ecken_und_kanten.pdf), 2006.
- [69] ———, *Some remarks on lower bounds on the  $p$ -domination number in trees*, J. Combin. Math. Combin. Comput. **61** (2007), 159–167.
- [70] ———, *A Nordhaus-Gaddum-type result for the 2-domination number*, J. Combin. Math. Combin. Comput. **64** (2008), 227–235.
- [71] ———, *Connected  $p$ -domination in graphs*, Util. Math. **79** (2009), 81–90.
- [72] V. K. Wei, *Coding for a multiple access channel*, Ph. D. Thesis, University of Hawaii, Honolulu, 1980.
- [73] Hua-Ming Xing, Liang Sun, and Xue-Gang Chen, *Domination in graphs of minimum degree five*, Graphs Combin. **22** (2006), no. 1, 127–143.

# List of notations

|                       |  |    |
|-----------------------|--|----|
| $(A, B)$              | set of edges with one vertex in $A$ and one in $B$ | 1  |
| $C_n$                 | cycle of length $n$                                | 2  |
| $d(v) = d_G(v)$       | degree of $v$                                      | 1  |
| $d(x, y) = d_G(x, y)$ | distance between $x$ and $y$                       | 1  |
| $E = E(G)$            | edge set   | 1  |
| $G_1 \circ G_2$       | $G_2$ -corona of $G_1$                             | 2  |
| $G_1 \times G_2$      | cartesian product of $G_1$ and $G_2$               | 45 |
| $\overline{G}$        | complement of $G$                                  | 1  |
| $G[S]$                | graph induced by $S$                               | 1  |
| $i(G)$                | independent domination number                      | 72 |
| $K_n$                 | complete graph of order $n$                        | 2  |
| $K_{p,q}$             | complete bipartite graph                           | 2  |
| $K_{1,t}$             | star   | 2  |
| $L(G)$                | set of leaves                                      | 1  |
| $\mathcal{L}(G)$      | line graph of $G$                                  | 49 |
| $m(A, B)$             | cardinality of $(A, B)$                            | 1  |
| $m = m(G)$            | size   | 1  |
| $n = n(G)$            | order  | 1  |
| $N(S) = N_G(S)$       | open neighborhood of the set $S$                   | 1  |
| $N(S, H) = N_G(S, H)$ | neighbors of $S$ with respect to $H$               | 1  |
| $N(v) = N_G(v)$       | open neighborhood                                  | 1  |
| $N[S] = N_G[S]$       | closed neighborhood of the set $S$                 | 1  |
| $N[v] = N_G[v]$       | closed neighborhood                                | 1  |
| $sf_k(G)$             | $k$ -star forming set number                       | 90 |
| $SS_t$                | subdivided star                                    | 2  |
| $SS_{s,t}$            | subdivided double star                             | 2  |
| $S(G)$                | subdivision graph                                  | 2  |
| $S_{s,t}$             | double star  | 2  |
| $V = V(G)$            | vertex set   | 1  |
| $\alpha(G)$           | independence number                                | 15 |
| $\alpha_k(G)$         | $k$ -dependence number                             | 15 |

---

|                     |  |     |
|---------------------|--|-----|
| $\alpha_0(G)$       | matching number                        | 81  |
| $\beta(G)$          | covering number                        | 39  |
| $\gamma(G)$         | domination number                      | 3   |
| $\gamma_c(G)$       | connected domination number            | 90  |
| $\gamma_{c,t}(G)$   | connected total domination number      | 97  |
| $\gamma_f(G)$       | $f$ -domination number                 | 6   |
| $\gamma_k(G)$       | $k$ -domination number                 | 4   |
| $\gamma_{kR}(G)$    | Roman $k$ -domination number           | 104 |
| $\gamma_k^c(G)$     | connected $k$ -domination number       | 97  |
| $\gamma_k^{c,t}(G)$ | connected total $k$ -domination number | 97  |
| $\gamma_k^t(G)$     | total $k$ -domination number           | 97  |
| $\gamma_R(G)$       | Roman domination number                | 104 |
| $\gamma_t(G)$       | total domination number                | 90  |
| $\delta(G)$         | minimum degree                         | 1   |
| $\Delta(G)$         | maximum degree                         | 1   |
| $\mu_o(G)$          | odd index                              | 82  |
| $\nu_e(G)$          | number of even cycles                  | 83  |
| $\nu_o(G)$          | number of odd cycles                   | 83  |
| $\chi(G)$           | chromatic number                       | 2   |

# Index

- $(F, k)$ -core, 21
- $C_4$ -cactus, 2
- $\varphi(G)$ -set, 2
- $f$ -dominating set, 6
- $f$ -domination number, 6
- $k$ -dependence number, 15
- $k$ -dependent set, 15
- $k$ -dominating set, 4
  - connected, 97
  - connected total, 97
  - total, 97
- $k$ -domination number, 4
  - connected, 97
  - connected total, 97
  - total, 97
- $k$ -semiregular, 4
- $k$ -star forming set, 90
- $r$ -regular, 1
  
- alternating path, 81
  
- block, 2
  - end, 2
- block graph, 2
- block-cactus graph, 2
- bridge, 2
  
- cactus graph, 2
- cartesian product, 45
- chromatic number, 2
- claw-free graph, 43
- clique, 2
- color, 2
- coloring, 2
  - proper, 2
- column, 45
- complement, 1
- complete bipartite graph, 2
- complete graph, 2
- connected dominating set, 90
- corona, 2
- corona graph, 2
- covering, 39
- covering number, 39
- cubic graph, 2
- cut vertex, 2
- cycle, 2
  
- degree, 1
  - maximum, 1
  - minimum, 1
- diagonal, 45
- distance, 1
- dominating set, 3
- domination number, 3
- double star, 2
  
- edge set, 1
  
- generalized star, 2
  
- independence number, 15
- independent dominating set, 72
- independent domination number, 72
- independent set, 15
- induced subgraph, 1
- inflated vertex, 45
  
- leaf, 1

line graph, 49

matching, 81  
    maximum, 81

matching number, 81

maximum set w.r.t. a property, 2

minimum set w.r.t. a property, 2

multiple domination, 4

neighborhood  
    closed, 1  
    open, 1

order, 1

regular graph, 1

Roman  $k$ -dominating function, 103  
    weight of a, 104

Roman  $k$ -domination number, 104

Roman domination number, 104

row, 45

semiregular, 1

size, 1

star, 2

subdivision graph, 2

total dominating set, 90

transversal, 45

tree, 2

triangulated graph, 2

unicyclic, 2

vertex set, 1

# Lebenslauf

## Zur Person

Name: Hansberg Pastor  
Vorname: Adriana  
Geburtsdatum: 14.09.1978  
Geburtsort: Mexiko-Stadt  
Nationalität: spanisch

## Schulausbildung

05.1998: Erwerb des Mexikanischen Schulabschlusses (CCH) und des deutschen Abiturs an der Deutschen Schule Alexander von Humboldt in Mexiko-Stadt

## Hochschulausbildung

09.1998 - 03.2000: Mathematikstudentin an der Nationalen Autonomen Universität Mexikos (UNAM) in Mexiko-Stadt (wegen damaligen politischem Streik abgebrochen)  
04.2000 - 04.2006: Studium der Mathematik an der RWTH Aachen mit Nebenfach Informatik

## Berufstätigkeit

04.2003 - 04.2006: Studentische Hilfskraft am Lehrstuhl II für Mathematik der RWTH Aachen  
10.2004 - 03.2005: Studentische Hilfskraft am Lehrstuhl B der RWTH Aachen  
09.2006: Tutorin beim Mathematikvorkurs der RWTH Aachen  
seit 05.2006: Wissenschaftliche Hilfskraft am Lehrstuhl II für Mathematik der RWTH Aachen

## Stipendien

seit 10.2006: Stipendiatin der Graduiertenförderung nach Richtlinien zur Förderung des wissenschaftlichen Nachwuchses der RWTH Aachen (RFwN)